

# equilibrium®



Attractive. Reliable. Proven.





# The equilibrium® family.

equilibrium® **mini**

equilibrium® **2**

equilibrium® **ti**

The equilibrium® series is Dentaurem's classic bracket series. Reliable results in patient treatment over many years have proven that the attractive and functional design is successful.

The brackets from the equilibrium® family are formed and milled from rod material and undergo many fully-automated processing steps. Like many other Dentaurem brackets, they are genuine one-piece brackets.

equilibrium® 2 and equilibrium® mini brackets are produced in one piece – body and base – from high-strength, stainless steel\*. equilibrium® ti brackets are made from titanium\*\* and are nickel-free. brackets from the equilibrium® family are particularly biocompatible as no solders are used.

\* Material number acc. to DIN 1.4404

\*\* Material number acc. to DIN 3.7035

# An overview of the equilibrium® brackets.



## equilibrium® **mini**

The mini bracket.

equilibrium® mini is one of the smallest Dentaurem brackets with the lowest profile. It is however in no way inferior to its big brother.

## equilibrium® 2

Harmony in function and comfort.

The classic equilibrium® bracket has been constantly revised and improved. Its design has reached worldwide recognition and has impressed users for many years. The low In/Out values enable equilibrium® mini und equilibrium® ti to be combined individually.



## equilibrium® ti

### Outstanding biocompatibility.

equilibrium® ti brackets are made of titanium and are nickel-free. Titanium is biocompatible, able to withstand high mechanical loading and is therefore ideal for use in orthodontics.

### Characteristics that are convincing.

- The FDI marking on the laser-structured base is abrasion resistant and does not contain any harmful coloring agents.
- Micro and macro retentions make optimum bonding possible whilst guaranteeing safe debonding.
- The design of the rhomboid base with central marking facilitates placement on the clinical crown.
- The brackets are laser-marked to ensure they can be clearly identified and positioned.
- The low In/Out values enable an ideal application of force.

## Optimal size.

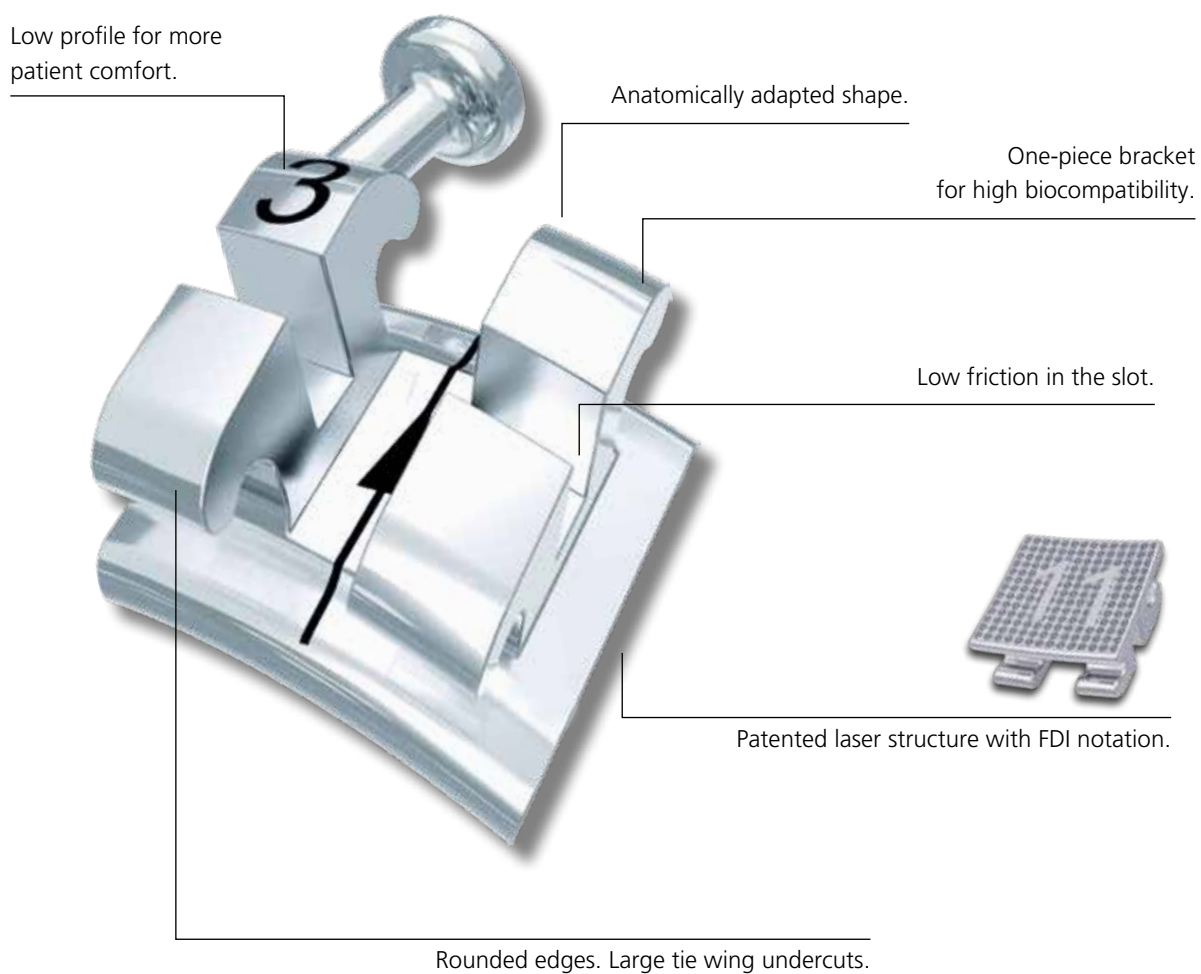



## Mini bracket – maximum performance.

- One of the smallest brackets in the world.
- One-piece bracket.
- Laser-structured base with FDI notation.
- Maximum functionality with aesthetics unequalled to date.
- Complete control of torque and angulation, despite small size.

Comparison in size equilibrium® 2 / equilibrium® mini





Optimal size.

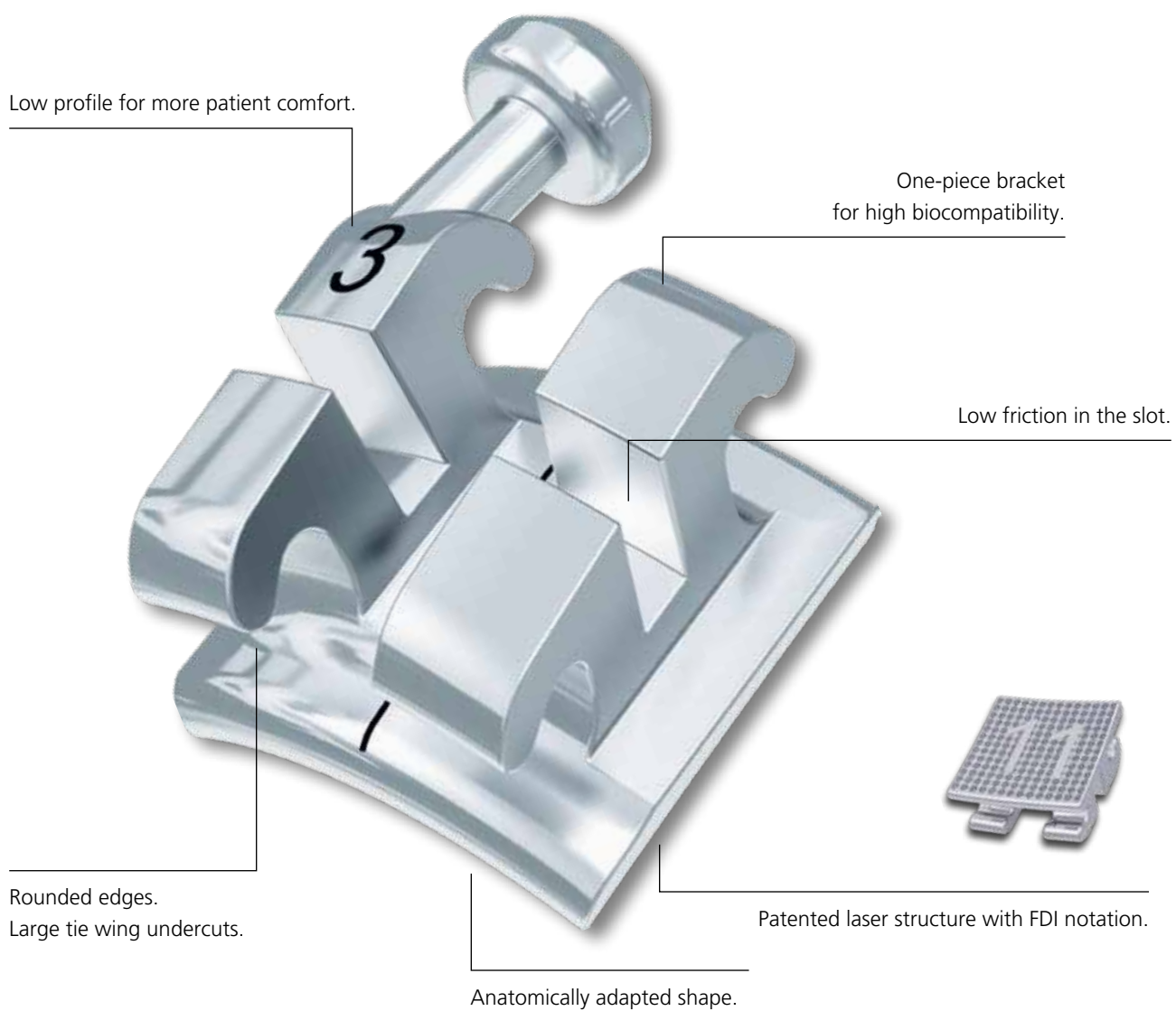





### Outstanding bracket design guarantees easy handling.

- Generous undercuts on bracket tie wings.
- Multiple ligatures possible.
- One-piece bracket.
- Laser-structured base with FDI notation.
- Central marking facilitates placement on the clinical crown.

Optimally compatible.

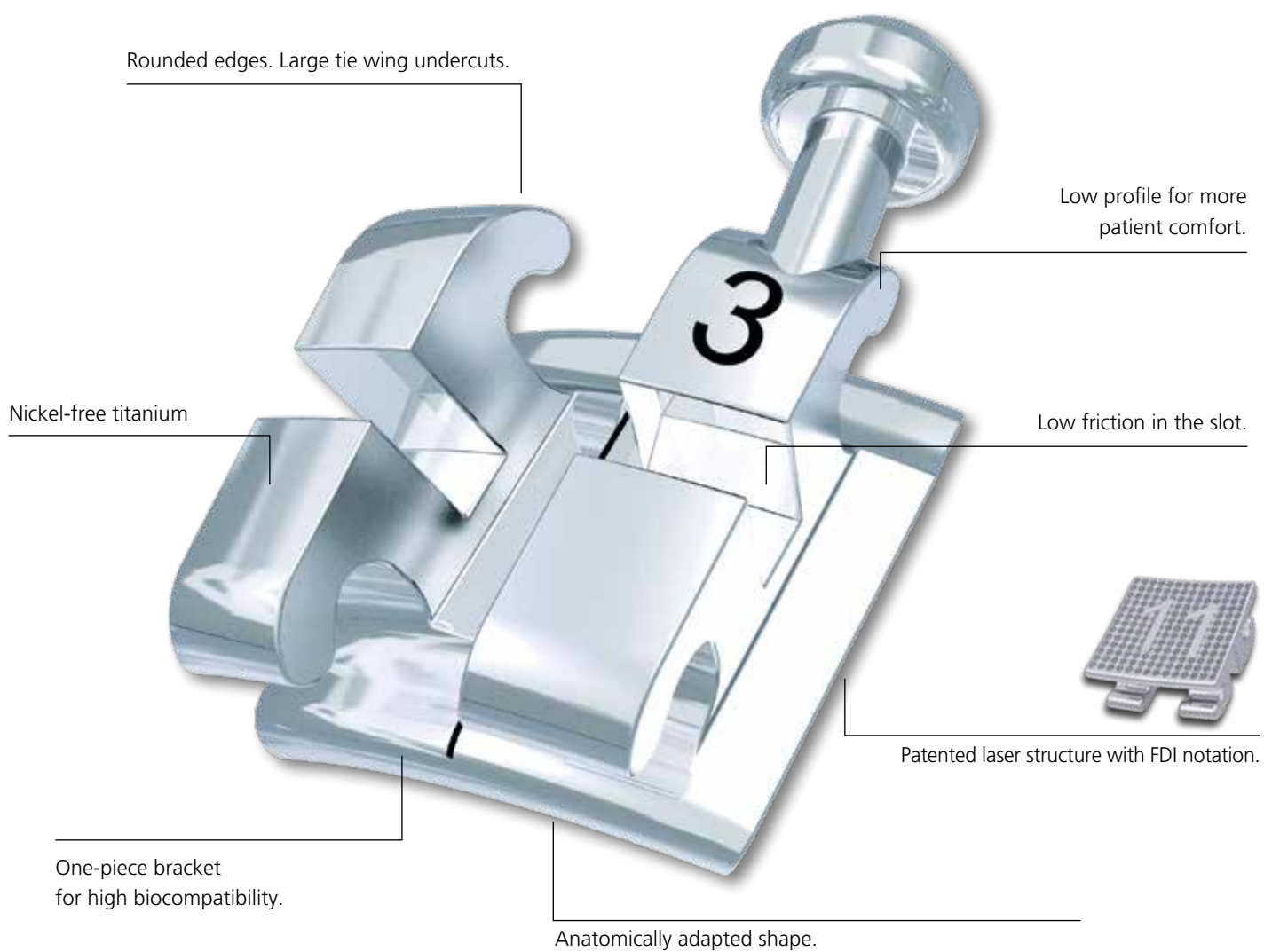



Ideal solution for patients with nickel allergy.

- Highly biocompatible.
- In titanium and nickel-free.
- Low friction\* due to special surface treatment.
- Worldwide recognized equilibrium® 2 design.
- Patented laser-structured base with FDI notation.

\* Friction values comparable to those of stainless steel brackets.

# Product overview.

## equilibrium® mini / Assortments

### Roth 18

Slot: 0,46 x 0,76 mm / 18 x 30 · Cuspid brackets with hook

<b>Torque</b>	- 7°	- 7°	- 2°	+ 8°	+ 12°	+ 12°	+ 8°	- 2°	- 7°	- 7°
<b>Angulation</b>	0°	0°	+ 13°	+ 9°	+ 5°	+ 5°	+ 9°	+ 13°	0°	0°
<b>In/Out</b>	0,7 mm	0,7 mm	0,7 mm	1,3 mm	0,7 mm	0,7 mm	1,3 mm	0,7 mm	0,7 mm	0,7 mm
<b>Width</b>	2,4 mm	2,4 mm	2,4 mm	2,2 mm	2,4 mm	2,4 mm	2,2 mm	2,4 mm	2,4 mm	2,4 mm
<b>REF</b>	<b>718-401-15</b>	<b>718-401-14</b>	<b>718-441-13</b>	<b>718-401-12</b>	<b>718-401-11</b>	<b>718-401-21</b>	<b>718-401-22</b>	<b>718-441-23</b>	<b>718-401-24</b>	<b>718-401-25</b>
<b>Quantity</b>	10 pieces	10 pieces	10 pieces	10 pieces	10 pieces	10 pieces	10 pieces	10 pieces	10 pieces	10 pieces

CE 0483

Even easier bracket identification with FDI-marking on the base!

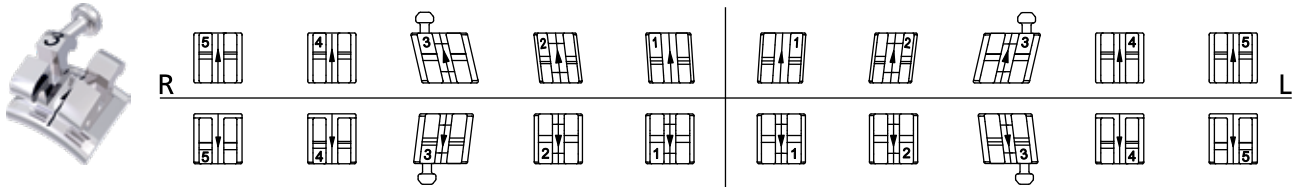

<b>Torque</b>	- 22°	- 17°	- 11°	- 1°	- 1°	- 1°	- 1°	- 11°	- 17°	- 22°
<b>Angulation</b>	0°	0°	+ 7°	0°	0°	0°	0°	+ 7°	0°	0°
<b>In/Out</b>	0,7 mm	0,7 mm	0,7 mm	1,3 mm	1,3 mm	1,3 mm	1,3 mm	0,7 mm	0,7 mm	0,7 mm
<b>Width</b>	2,4 mm	2,4 mm	2,4 mm	2,2 mm	2,2 mm	2,2 mm	2,2 mm	2,4 mm	2,4 mm	2,4 mm
<b>REF</b>	<b>718-401-45</b>	<b>718-401-44</b>	<b>718-441-43</b>	<b>718-401-42</b>	<b>718-401-41</b>	<b>718-401-31</b>	<b>718-401-32</b>	<b>718-441-33</b>	<b>718-401-34</b>	<b>718-401-35</b>
<b>Quantity</b>	10 pieces	10 pieces	10 pieces	10 pieces	10 pieces	10 pieces	10 pieces	10 pieces	10 pieces	10 pieces

#### Assortments:

1 case	20 brackets	<b>REF 718-401-01</b>
10 cases	200 brackets	<b>REF 718-401-10</b>
50 cases	1.000 brackets	<b>REF 718-401-50</b>

### Roth 18

Slot: 0,46 x 0,76 mm / 18 x 30 · Hook on cuspid, 1st bicuspid and 2nd bicuspid brackets

<b>Torque</b>	- 7°	- 7°	- 2°	+ 8°	+ 12°	+ 12°	+ 8°	- 2°	- 7°	- 7°
<b>Angulation</b>	0°	0°	+ 13°	+ 9°	+ 5°	+ 5°	+ 9°	+ 13°	0°	0°
<b>In/Out</b>	0,7 mm	0,7 mm	0,7 mm	1,3 mm	0,7 mm	0,7 mm	1,3 mm	0,7 mm	0,7 mm	0,7 mm
<b>Width</b>	2,4 mm	2,4 mm	2,4 mm	2,2 mm	2,4 mm	2,4 mm	2,2 mm	2,4 mm	2,4 mm	2,4 mm
<b>REF</b>	<b>718-441-15</b>	<b>718-441-14</b>	<b>718-441-13</b>	<b>718-401-12</b>	<b>718-401-11</b>	<b>718-401-21</b>	<b>718-401-22</b>	<b>718-441-23</b>	<b>718-441-24</b>	<b>718-441-25</b>
<b>Quantity</b>	10 pieces	10 pieces	10 pieces	10 pieces	10 pieces	10 pieces	10 pieces	10 pieces	10 pieces	10 pieces

CE 0483

Even easier bracket identification with FDI-marking on the base!

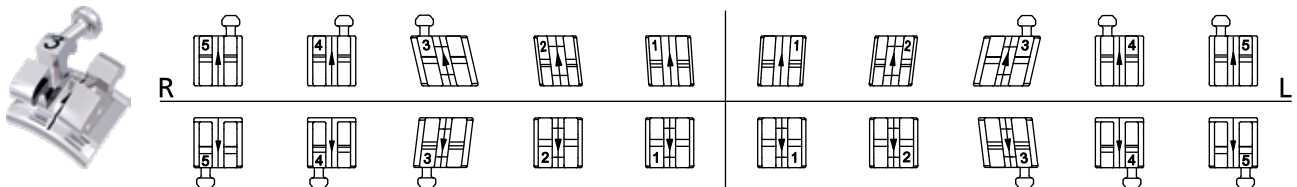

<b>Torque</b>	- 22°	- 17°	- 11°	- 1°	- 1°	- 1°	- 1°	- 11°	- 17°	- 22°
<b>Angulation</b>	0°	0°	+ 7°	0°	0°	0°	0°	+ 7°	0°	0°
<b>In/Out</b>	0,7 mm	0,7 mm	0,7 mm	1,3 mm	1,3 mm	1,3 mm	1,3 mm	0,7 mm	0,7 mm	0,7 mm
<b>Width</b>	2,4 mm	2,4 mm	2,4 mm	2,2 mm	2,2 mm	2,2 mm	2,2 mm	2,4 mm	2,4 mm	2,4 mm
<b>REF</b>	<b>718-441-45</b>	<b>718-441-44</b>	<b>718-441-43</b>	<b>718-401-42</b>	<b>718-401-41</b>	<b>718-401-31</b>	<b>718-401-32</b>	<b>718-441-33</b>	<b>718-441-34</b>	<b>718-441-35</b>
<b>Quantity</b>	10 pieces	10 pieces	10 pieces	10 pieces	10 pieces	10 pieces	10 pieces	10 pieces	10 pieces	10 pieces

#### Assortments:

1 case	20 brackets	<b>REF 718-441-01</b>
10 cases	200 brackets	<b>REF 718-441-10</b>
50 cases	1.000 brackets	<b>REF 718-441-50</b>

Maxillary      Mandibular      Maxillary + Mandibular / Assortments

# equilibrium® mini / Assortments

## Roth 22

Slot: 0,56 x 0,76 mm / 22 x 30 · Cuspid brackets with hook

<b>Torque</b>	- 7°	- 7°	- 2°	+ 8°	+ 12°	+ 12°	+ 8°	- 2°	- 7°	- 7°
<b>Angulation</b>	0°	0°	+ 13°	+ 9°	+ 5°	+ 5°	+ 9°	+ 13°	0°	0°
<b>In/Out</b>	0,7 mm	0,7 mm	0,7 mm	1,3 mm	0,7 mm	0,7 mm	1,3 mm	0,7 mm	0,7 mm	0,7 mm
<b>Width</b>	2,4 mm	2,4 mm	2,4 mm	2,2 mm	2,4 mm	2,4 mm	2,2 mm	2,4 mm	2,4 mm	2,4 mm
<b>REF</b>	<b>722-401-15</b>	<b>722-401-14</b>	<b>722-441-13</b>	<b>722-401-12</b>	<b>722-401-11</b>	<b>722-401-21</b>	<b>722-401-22</b>	<b>722-441-23</b>	<b>722-401-24</b>	<b>722-401-25</b>
<b>Quantity</b>	10 pieces	10 pieces	10 pieces	10 pieces	10 pieces	10 pieces	10 pieces	10 pieces	10 pieces	10 pieces

CE 0483

Even easier bracket identification with FDI-marking on the base!

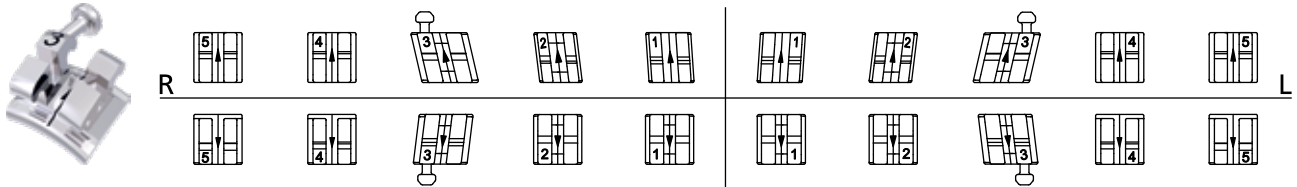

<b>Torque</b>	- 22°	- 17°	- 11°	- 1°	- 1°	- 1°	- 1°	- 11°	- 17°	- 22°
<b>Angulation</b>	0°	0°	+ 7°	0°	0°	0°	0°	+ 7°	0°	0°
<b>In/Out</b>	0,7 mm	0,7 mm	0,7 mm	1,3 mm	1,3 mm	1,3 mm	1,3 mm	0,7 mm	0,7 mm	0,7 mm
<b>Width</b>	2,4 mm	2,4 mm	2,4 mm	2,2 mm	2,2 mm	2,2 mm	2,2 mm	2,4 mm	2,4 mm	2,4 mm
<b>REF</b>	<b>722-401-45</b>	<b>722-401-44</b>	<b>722-441-43</b>	<b>722-401-42</b>	<b>722-401-41</b>	<b>722-401-31</b>	<b>722-401-32</b>	<b>722-441-33</b>	<b>722-401-34</b>	<b>722-401-35</b>
<b>Quantity</b>	10 pieces	10 pieces	10 pieces	10 pieces	10 pieces	10 pieces	10 pieces	10 pieces	10 pieces	10 pieces

### Assortments:

1 case	20 brackets	<b>REF 722-401-01</b>
10 cases	200 brackets	<b>REF 722-401-10</b>
50 cases	1.000 brackets	<b>REF 722-401-50</b>

## Roth 22

Slot: 0,56 x 0,76 mm / 22 x 30 · Hook on cuspid, 1st bicuspid and 2nd bicuspid brackets

<b>Torque</b>	- 7°	- 7°	- 2°	+ 8°	+ 12°	+ 12°	+ 8°	- 2°	- 7°	- 7°
<b>Angulation</b>	0°	0°	+ 13°	+ 9°	+ 5°	+ 5°	+ 9°	+ 13°	0°	0°
<b>In/Out</b>	0,7 mm	0,7 mm	0,7 mm	1,3 mm	0,7 mm	0,7 mm	1,3 mm	0,7 mm	0,7 mm	0,7 mm
<b>Width</b>	2,4 mm	2,4 mm	2,4 mm	2,2 mm	2,4 mm	2,4 mm	2,2 mm	2,4 mm	2,4 mm	2,4 mm
<b>REF</b>	<b>722-441-15</b>	<b>722-441-14</b>	<b>722-441-13</b>	<b>722-401-12</b>	<b>722-401-11</b>	<b>722-401-21</b>	<b>722-401-22</b>	<b>722-441-23</b>	<b>722-441-24</b>	<b>722-441-25</b>
<b>Quantity</b>	10 pieces	10 pieces	10 pieces	10 pieces	10 pieces	10 pieces	10 pieces	10 pieces	10 pieces	10 pieces

CE 0483

Even easier bracket identification with FDI-marking on the base!

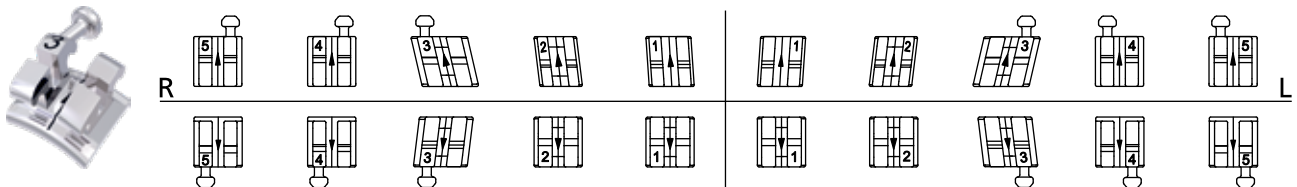

<b>Torque</b>	- 22°	- 17°	- 11°	- 1°	- 1°	- 1°	- 1°	- 11°	- 17°	- 22°
<b>Angulation</b>	0°	0°	+ 7°	0°	0°	0°	0°	+ 7°	0°	0°
<b>In/Out</b>	0,7 mm	0,7 mm	0,7 mm	1,3 mm	1,3 mm	1,3 mm	1,3 mm	0,7 mm	0,7 mm	0,7 mm
<b>Width</b>	2,4 mm	2,4 mm	2,4 mm	2,2 mm	2,2 mm	2,2 mm	2,2 mm	2,4 mm	2,4 mm	2,4 mm
<b>REF</b>	<b>722-441-45</b>	<b>722-441-44</b>	<b>722-441-43</b>	<b>722-401-42</b>	<b>722-401-41</b>	<b>722-401-31</b>	<b>722-401-32</b>	<b>722-441-33</b>	<b>722-441-34</b>	<b>722-441-35</b>
<b>Quantity</b>	10 pieces	10 pieces	10 pieces	10 pieces	10 pieces	10 pieces	10 pieces	10 pieces	10 pieces	10 pieces

### Assortments:

1 case	20 brackets	<b>REF 722-441-01</b>
10 cases	200 brackets	<b>REF 722-441-10</b>
50 cases	1.000 brackets	<b>REF 722-441-50</b>

Maxillary

Mandibular

Maxillary + Mandibular / Assortments

# equilibrium® mini / Assortments

## McLaughlin-Bennett-Trevisi\*\* 18

Slot: 0,46 x 0,76 mm / 18 x 30 · Cuspid brackets with hook

<b>Torque</b>	- 7°	- 7°	0°	+ 10°	+ 17°	+ 17°	+ 10°	0°	- 7°	- 7°
<b>Angulation</b>	0°	0°	+ 8°	+ 8°	+ 4°	+ 4°	+ 8°	+ 8°	0°	0°
<b>In/Out</b>	1,2 mm	0,7 mm	0,7 mm	1,3 mm	0,7 mm	0,7 mm	1,3 mm	0,7 mm	0,7 mm	1,2 mm
<b>Width</b>	2,4 mm	2,4 mm	2,4 mm	2,2 mm	2,4 mm	2,4 mm	2,2 mm	2,4 mm	2,4 mm	2,4 mm
<b>REF</b>	<b>718-402-15</b>	<b>718-402-14</b>	<b>718-442-13</b>	<b>718-402-12</b>	<b>718-402-11</b>	<b>718-402-21</b>	<b>718-402-22</b>	<b>718-442-23</b>	<b>718-402-24</b>	<b>718-402-25</b>
<b>Quantity</b>	10 pieces	10 pieces	10 pieces	10 pieces	10 pieces	10 pieces	10 pieces	10 pieces	10 pieces	10 pieces

CE 0483

Even easier bracket identification with FDI-marking on the base!

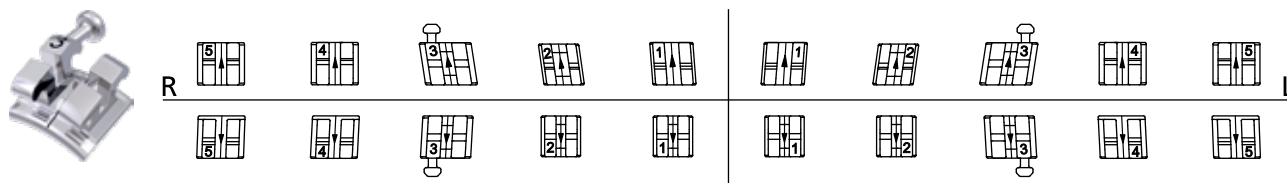

<b>Torque</b>	- 17°	- 12°	0°	- 6°	- 6°	- 6°	- 6°	0°	- 12°	- 17°
<b>Angulation</b>	+ 2°	+ 2°	+ 3°	0°	0°	0°	0°	+ 3°	+ 2°	+ 2°
<b>In/Out</b>	0,7 mm	0,7 mm	0,7 mm	1,3 mm	1,3 mm	1,3 mm	1,3 mm	0,7 mm	0,7 mm	0,7 mm
<b>Width</b>	2,4 mm	2,4 mm	2,4 mm	2,2 mm	2,2 mm	2,2 mm	2,2 mm	2,4 mm	2,4 mm	2,4 mm
<b>REF</b>	<b>718-402-45</b>	<b>718-402-44</b>	<b>718-442-43</b>	<b>718-402-42</b>	<b>718-402-41</b>	<b>718-402-31</b>	<b>718-402-32</b>	<b>718-442-33</b>	<b>718-402-34</b>	<b>718-402-35</b>
<b>Quantity</b>	10 pieces	10 pieces	10 pieces	10 pieces	10 pieces	10 pieces	10 pieces	10 pieces	10 pieces	10 pieces

### Assortments:

1 case	20 brackets	<b>REF 718-402-01</b>
10 cases	200 brackets	<b>REF 718-402-10</b>
50 cases	1.000 brackets	<b>REF 718-402-50</b>

### Note:

Other brackets with McLaughlin-Bennett-Trevisi\*\* values see single packs.

\*\* The Dentaaurum version of this prescription is not claimed to be a duplication of any other, nor does Dentaaurum imply that it is endorsed in any way by Drs. McLaughlin, Bennett and Trevisi.

## McLaughlin-Bennett-Trevisi\*\* 18

Slot: 0,46 x 0,76 mm / 18 x 30 · Hook on cuspid, 1st bicuspid and 2nd bicuspid brackets

<b>Torque</b>	- 7°	- 7°	0°	+ 10°	+ 17°	+ 17°	+ 10°	0°	- 7°	- 7°
<b>Angulation</b>	0°	0°	+ 8°	+ 8°	+ 4°	+ 4°	+ 8°	+ 8°	0°	0°
<b>In/Out</b>	1,2 mm	0,7 mm	0,7 mm	1,3 mm	0,7 mm	0,7 mm	1,3 mm	0,7 mm	0,7 mm	1,2 mm
<b>Width</b>	2,4 mm	2,4 mm	2,4 mm	2,2 mm	2,4 mm	2,4 mm	2,2 mm	2,4 mm	2,4 mm	2,4 mm
<b>REF</b>	<b>718-442-15</b>	<b>718-442-14</b>	<b>718-442-13</b>	<b>718-402-12</b>	<b>718-402-11</b>	<b>718-402-21</b>	<b>718-402-22</b>	<b>718-442-23</b>	<b>718-442-24</b>	<b>718-442-25</b>
<b>Quantity</b>	10 pieces	10 pieces	10 pieces	10 pieces	10 pieces	10 pieces	10 pieces	10 pieces	10 pieces	10 pieces

CE 0483

Even easier bracket identification with FDI-marking on the base!

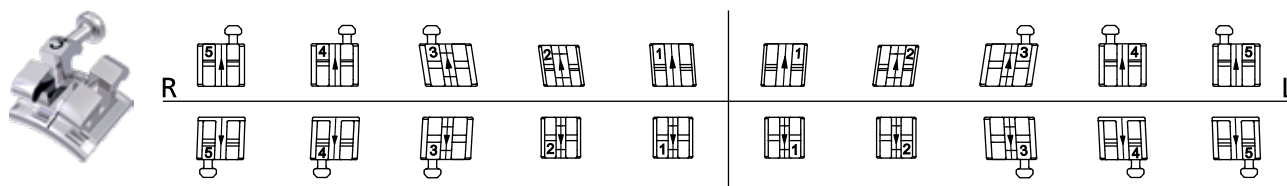

<b>Torque</b>	- 17°	- 12°	0°	- 6°	- 6°	- 6°	- 6°	0°	- 12°	- 17°
<b>Angulation</b>	+ 2°	+ 2°	+ 3°	0°	0°	0°	0°	+ 3°	+ 2°	+ 2°
<b>In/Out</b>	0,7 mm	0,7 mm	0,7 mm	1,3 mm	1,3 mm	1,3 mm	1,3 mm	0,7 mm	0,7 mm	0,7 mm
<b>Width</b>	2,4 mm	2,4 mm	2,4 mm	2,2 mm	2,2 mm	2,2 mm	2,2 mm	2,4 mm	2,4 mm	2,4 mm
<b>REF</b>	<b>718-442-45</b>	<b>718-442-44</b>	<b>718-442-43</b>	<b>718-402-42</b>	<b>718-402-41</b>	<b>718-402-31</b>	<b>718-402-32</b>	<b>718-442-33</b>	<b>718-442-34</b>	<b>718-442-35</b>
<b>Quantity</b>	10 pieces	10 pieces	10 pieces	10 pieces	10 pieces	10 pieces	10 pieces	10 pieces	10 pieces	10 pieces

### Assortments:

1 case	20 brackets	<b>REF 718-442-01</b>
10 cases	200 brackets	<b>REF 718-442-10</b>
50 cases	1.000 brackets	<b>REF 718-442-50</b>

### Note:

Other brackets with McLaughlin-Bennett-Trevisi\*\* values see single packs.

\*\* The Dentaaurum version of this prescription is not claimed to be a duplication of any other, nor does Dentaaurum imply that it is endorsed in any way by Drs. McLaughlin, Bennett and Trevisi.

Maxillary Mandibular Maxillary + Mandibular / Assortments



# equilibrium® mini / Assortments

## McLaughlin-Bennett-Trevisi\*\* 22

Slot: 0,56 x 0,76 mm / 22 x 30 · Cuspid brackets with hook

<b>Torque</b>	- 7°	- 7°	0°	+ 10°	+ 17°	+ 17°	+ 10°	0°	- 7°	- 7°
<b>Angulation</b>	0°	0°	+ 8°	+ 8°	+ 4°	+ 4°	+ 8°	+ 8°	0°	0°
<b>In/Out</b>	1,2 mm	0,7 mm	0,7 mm	1,3 mm	0,7 mm	0,7 mm	1,3 mm	0,7 mm	0,7 mm	1,2 mm
<b>Width</b>	2,4 mm	2,4 mm	2,4 mm	2,2 mm	2,4 mm	2,4 mm	2,2 mm	2,4 mm	2,4 mm	2,4 mm
<b>REF</b>	<b>722-402-15</b>	<b>722-402-14</b>	<b>722-442-13</b>	<b>722-402-12</b>	<b>722-402-11</b>	<b>722-402-21</b>	<b>722-402-22</b>	<b>722-442-23</b>	<b>722-402-24</b>	<b>722-402-25</b>
<b>Quantity</b>	10 pieces	10 pieces	10 pieces	10 pieces	10 pieces	10 pieces	10 pieces	10 pieces	10 pieces	10 pieces

CE 0483

Even easier bracket identification with FDI-marking on the base!

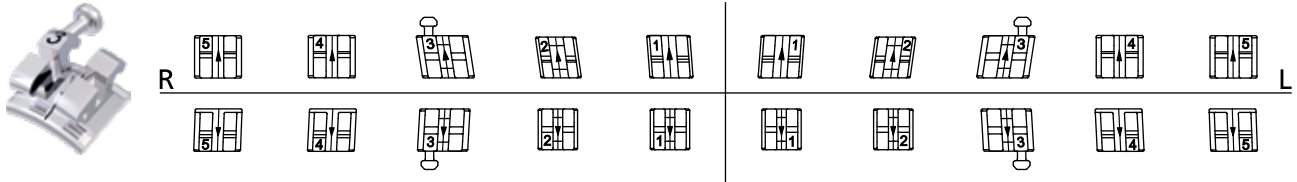

<b>Torque</b>	- 17°	- 12°	0°	- 6°	- 6°	- 6°	- 6°	0°	- 12°	- 17°
<b>Angulation</b>	+ 2°	+ 2°	+ 3°	0°	0°	0°	0°	+ 3°	+ 2°	+ 2°
<b>In/Out</b>	0,7 mm	0,7 mm	0,7 mm	1,3 mm	1,3 mm	1,3 mm	1,3 mm	0,7 mm	0,7 mm	0,7 mm
<b>Width</b>	2,4 mm	2,4 mm	2,4 mm	2,2 mm	2,2 mm	2,2 mm	2,2 mm	2,4 mm	2,4 mm	2,4 mm
<b>REF</b>	<b>722-402-45</b>	<b>722-402-44</b>	<b>722-442-43</b>	<b>722-402-42</b>	<b>722-402-41</b>	<b>722-402-31</b>	<b>722-402-32</b>	<b>722-442-33</b>	<b>722-402-34</b>	<b>722-402-35</b>
<b>Quantity</b>	10 pieces	10 pieces	10 pieces	10 pieces	10 pieces	10 pieces	10 pieces	10 pieces	10 pieces	10 pieces

### Assortments:

1 case	20 brackets	<b>REF 722-402-01</b>
10 cases	200 brackets	<b>REF 722-402-10</b>
50 cases	1.000 brackets	<b>REF 722-402-50</b>

### Note:

Other brackets with McLaughlin-Bennett-Trevisi\*\* values see single packs.

\*\* The Dentaaurum version of this prescription is not claimed to be a duplication of any other, nor does Dentaaurum imply that it is endorsed in any way by Drs. McLaughlin, Bennett and Trevisi.

## McLaughlin-Bennett-Trevisi\*\* 22

Slot: 0,56 x 0,76 mm / 22 x 30 · Hook on cuspid, 1st bicuspid and 2nd bicuspid brackets

<b>Torque</b>	- 7°	- 7°	0°	+ 10°	+ 17°	+ 17°	+ 10°	0°	- 7°	- 7°
<b>Angulation</b>	0°	0°	+ 8°	+ 8°	+ 4°	+ 4°	+ 8°	+ 8°	0°	0°
<b>In/Out</b>	1,2 mm	0,7 mm	0,7 mm	1,3 mm	0,7 mm	0,7 mm	1,3 mm	0,7 mm	0,7 mm	1,2 mm
<b>Width</b>	2,4 mm	2,4 mm	2,4 mm	2,2 mm	2,4 mm	2,4 mm	2,2 mm	2,4 mm	2,4 mm	2,4 mm
<b>REF</b>	<b>722-442-15</b>	<b>722-442-14</b>	<b>722-442-13</b>	<b>722-402-12</b>	<b>722-402-11</b>	<b>722-402-21</b>	<b>722-402-22</b>	<b>722-442-23</b>	<b>722-442-24</b>	<b>722-442-25</b>
<b>Quantity</b>	10 pieces	10 pieces	10 pieces	10 pieces	10 pieces	10 pieces	10 pieces	10 pieces	10 pieces	10 pieces

CE 0483

Even easier bracket identification with FDI-marking on the base!

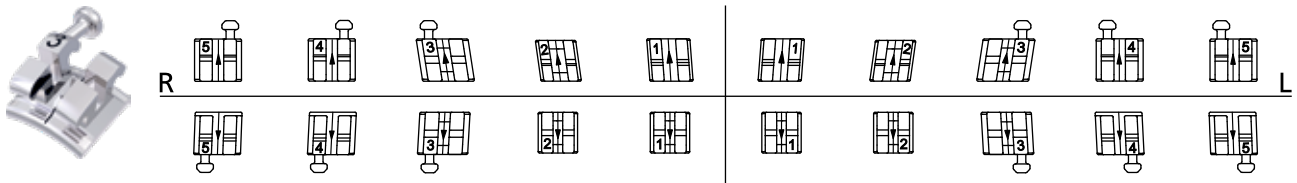

<b>Torque</b>	- 17°	- 12°	0°	- 6°	- 6°	- 6°	- 6°	0°	- 12°	- 17°
<b>Angulation</b>	+ 2°	+ 2°	+ 3°	0°	0°	0°	0°	+ 3°	+ 2°	+ 2°
<b>In/Out</b>	0,7 mm	0,7 mm	0,7 mm	1,3 mm	1,3 mm	1,3 mm	1,3 mm	0,7 mm	0,7 mm	0,7 mm
<b>Width</b>	2,4 mm	2,4 mm	2,4 mm	2,2 mm	2,2 mm	2,2 mm	2,2 mm	2,4 mm	2,4 mm	2,4 mm
<b>REF</b>	<b>722-442-45</b>	<b>722-442-44</b>	<b>722-442-43</b>	<b>722-402-42</b>	<b>722-402-41</b>	<b>722-402-31</b>	<b>722-402-32</b>	<b>722-442-33</b>	<b>722-442-34</b>	<b>722-442-35</b>
<b>Quantity</b>	10 pieces	10 pieces	10 pieces	10 pieces	10 pieces	10 pieces	10 pieces	10 pieces	10 pieces	10 pieces

### Assortments:

1 case	20 brackets	<b>REF 722-442-01</b>
10 cases	200 brackets	<b>REF 722-442-10</b>
50 cases	1.000 brackets	<b>REF 722-442-50</b>

### Note:

Other brackets with McLaughlin-Bennett-Trevisi\*\* values see single packs.

\*\* The Dentaaurum version of this prescription is not claimed to be a duplication of any other, nor does Dentaaurum imply that it is endorsed in any way by Drs. McLaughlin, Bennett and Trevisi.

Maxillary Mandibular Maxillary + Mandibular / Assortments

equilibrium® mini / Single packs – bonding technique

**McLaughlin-Bennett-Trevisi\*\* 18/22**



Teeth	Torque	Angulation	In/Out	Hook	Width	REF (18)	REF (22)	Quantity
11	+ 17°	+ 4°	0,7 mm		2,8 mm		<b>722-462-11</b>	10 pieces
21	+ 17°	+ 4°	0,7 mm		2,8 mm		<b>722-462-21</b>	10 pieces
12	+ 10°	+ 8°	1,3 mm		2,4 mm		<b>722-462-12</b>	10 pieces
22	+ 10°	+ 8°	1,3 mm		2,4 mm		<b>722-462-22</b>	10 pieces
15	- 7°	0°	0,7 mm		2,4 mm	<b>718-452-15</b>		10 pieces
25	- 7°	0°	0,7 mm		2,4 mm	<b>718-452-25</b>		10 pieces
15	- 7°	0°	0,7 mm	•	2,4 mm	<b>718-462-15</b>		10 pieces
25	- 7°	0°	0,7 mm	•	2,4 mm	<b>718-462-25</b>		10 pieces

CE 0483

Even easier bracket identification with FDI-marking on the base!

Slot 18: 0,46 x 0,76 mm / 18 x 30

Slot 22: 0,56 x 0,76 mm / 22 x 30

\*\* The Dentaaurum version of this prescription is not claimed to be a duplication of any other, nor does Dentaaurum imply that it is endorsed in any way by Drs. McLaughlin, Bennett and Trevisi.

Maxillary

**DENTAURUM** ONLINE SHOP  
shop.dentaaurum.com

**Roth 18**

Slot: 0,46 x 0,76 mm / 18 x 30 · Cuspid brackets with hook

<b>Torque</b>	- 7°	- 7°	- 2°	+ 8°	+ 12°	+ 12°	+ 8°	- 2°	- 7°	- 7°
<b>Angulation</b>	0°	0°	+ 13°	+ 9°	+ 5°	+ 5°	+ 9°	+ 13°	0°	0°
<b>In/Out</b>	0,7 mm	0,7 mm	0,7 mm	1,3 mm	0,7 mm	0,7 mm	1,3 mm	0,7 mm	0,7 mm	0,7 mm
<b>Width</b>	3,1 mm	3,1 mm	3,1 mm	3,0 mm	3,4 mm	3,4 mm	3,0 mm	3,1 mm	3,1 mm	3,1 mm
<b>REF</b>	<b>718-301-15</b>	<b>718-301-14</b>	<b>718-341-13</b>	<b>718-301-12</b>	<b>718-301-11</b>	<b>718-301-21</b>	<b>718-301-22</b>	<b>718-341-23</b>	<b>718-301-24</b>	<b>718-301-25</b>
<b>Quantity</b>	10 pieces	10 pieces	10 pieces	10 pieces	10 pieces	10 pieces	10 pieces	10 pieces	10 pieces	10 pieces

CE 0483

Even easier bracket identification with FDI-marking on the base!

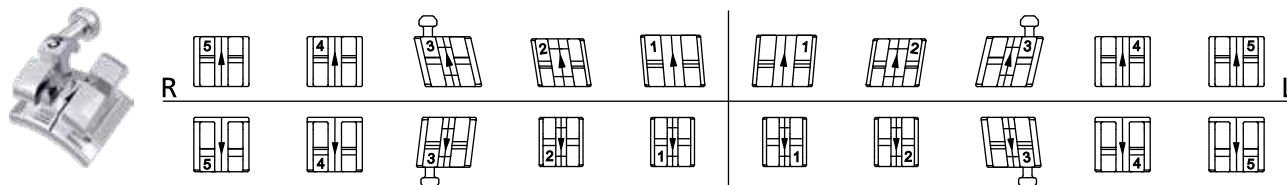

<b>Torque</b>	- 22°	- 17°	- 11°	- 1°	- 1°	- 1°	- 1°	- 11°	- 17°	- 22°
<b>Angulation</b>	0°	0°	+ 7°	0°	0°	0°	0°	+ 7°	0°	0°
<b>In/Out</b>	0,7 mm	0,7 mm	0,7 mm	1,3 mm	1,3 mm	1,3 mm	1,3 mm	0,7 mm	0,7 mm	0,7 mm
<b>Width</b>	3,1 mm	3,1 mm	3,1 mm	2,4 mm	2,4 mm	2,4 mm	2,4 mm	3,1 mm	3,1 mm	3,1 mm
<b>REF</b>	<b>718-301-45</b>	<b>718-301-44</b>	<b>718-341-43</b>	<b>718-301-42</b>	<b>718-301-41</b>	<b>718-301-31</b>	<b>718-301-32</b>	<b>718-341-33</b>	<b>718-301-34</b>	<b>718-301-35</b>
<b>Quantity</b>	10 pieces	10 pieces	10 pieces	10 pieces	10 pieces	10 pieces	10 pieces	10 pieces	10 pieces	10 pieces

**Assortments:**

1 case	20 brackets	<b>REF 718-301-01</b>
10 cases	200 brackets	<b>REF 718-301-10</b>
50 cases	1.000 brackets	<b>REF 718-301-50</b>

**Note:**

Other brackets with Roth values see single packs.

**Roth 18**

Slot: 0,46 x 0,76 mm / 18 x 30 · Hook on cuspid, 1st bicuspid and 2nd bicuspid brackets

<b>Torque</b>	- 7°	- 7°	- 2°	+ 8°	+ 12°	+ 12°	+ 8°	- 2°	- 7°	- 7°
<b>Angulation</b>	0°	0°	+ 13°	+ 9°	+ 5°	+ 5°	+ 9°	+ 13°	0°	0°
<b>In/Out</b>	0,7 mm	0,7 mm	0,7 mm	1,3 mm	0,7 mm	0,7 mm	1,3 mm	0,7 mm	0,7 mm	0,7 mm
<b>Width</b>	3,1 mm	3,1 mm	3,1 mm	3,0 mm	3,4 mm	3,4 mm	3,0 mm	3,1 mm	3,1 mm	3,1 mm
<b>REF</b>	<b>718-341-15</b>	<b>718-341-14</b>	<b>718-341-13</b>	<b>718-301-12</b>	<b>718-301-11</b>	<b>718-301-21</b>	<b>718-301-22</b>	<b>718-341-23</b>	<b>718-341-24</b>	<b>718-341-25</b>
<b>Quantity</b>	10 pieces	10 pieces	10 pieces	10 pieces	10 pieces	10 pieces	10 pieces	10 pieces	10 pieces	10 pieces

CE 0483

Even easier bracket identification with FDI-marking on the base!

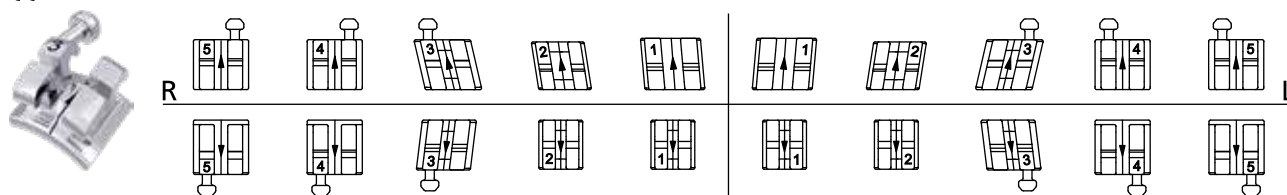

<b>Torque</b>	- 22°	- 17°	- 11°	- 1°	- 1°	- 1°	- 1°	- 11°	- 17°	- 22°
<b>Angulation</b>	0°	0°	+ 7°	0°	0°	0°	0°	+ 7°	0°	0°
<b>In/Out</b>	0,7 mm	0,7 mm	0,7 mm	1,3 mm	1,3 mm	1,3 mm	1,3 mm	0,7 mm	0,7 mm	0,7 mm
<b>Width</b>	3,1 mm	3,1 mm	3,1 mm	2,4 mm	2,4 mm	2,4 mm	2,4 mm	3,1 mm	3,1 mm	3,1 mm
<b>REF</b>	<b>718-341-45</b>	<b>718-341-44</b>	<b>718-341-43</b>	<b>718-301-42</b>	<b>718-301-41</b>	<b>718-301-31</b>	<b>718-301-32</b>	<b>718-341-33</b>	<b>718-341-34</b>	<b>718-341-35</b>
<b>Quantity</b>	10 pieces	10 pieces	10 pieces	10 pieces	10 pieces	10 pieces	10 pieces	10 pieces	10 pieces	10 pieces

**Assortments:**

1 case	20 brackets	<b>REF 718-341-01</b>
10 cases	200 brackets	<b>REF 718-341-10</b>
50 cases	1.000 brackets	<b>REF 718-341-50</b>

**Note:**

Other brackets with Roth values see single packs.

# equilibrium® 2 / Assortments

## Roth 22

Slot: 0,56 x 0,76 mm / 22 x 30 · Cuspid brackets with hook

<b>Torque</b>	- 7°	- 7°	- 2°	+ 8°	+ 12°	+ 12°	+ 8°	- 2°	- 7°	- 7°
<b>Angulation</b>	0°	0°	+ 13°	+ 9°	+ 5°	+ 5°	+ 9°	+ 13°	0°	0°
<b>In/Out</b>	0,7 mm	0,7 mm	0,7 mm	1,3 mm	0,7 mm	0,7 mm	1,3 mm	0,7 mm	0,7 mm	0,7 mm
<b>Width</b>	3,1 mm	3,1 mm	3,1 mm	3,0 mm	3,4 mm	3,4 mm	3,0 mm	3,1 mm	3,1 mm	3,1 mm
<b>REF</b>	<b>722-301-15</b>	<b>722-301-14</b>	<b>722-341-13</b>	<b>722-301-12</b>	<b>722-301-11</b>	<b>722-301-21</b>	<b>722-301-22</b>	<b>722-341-23</b>	<b>722-301-24</b>	<b>722-301-25</b>
<b>Quantity</b>	10 pieces	10 pieces	10 pieces	10 pieces	10 pieces	10 pieces	10 pieces	10 pieces	10 pieces	10 pieces

CE 0483

Even easier bracket identification with FDI-marking on the base!

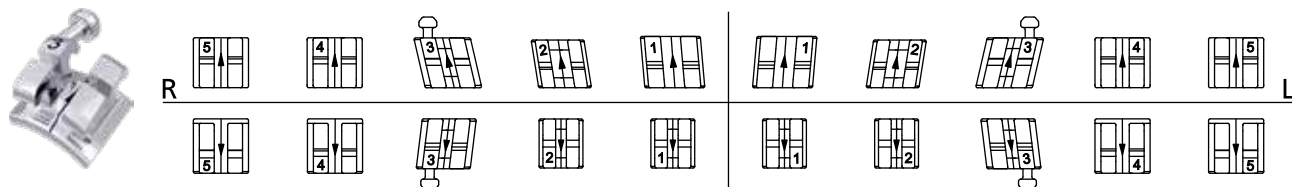

<b>Torque</b>	- 22°	- 17°	- 11°	- 1°	- 1°	- 1°	- 1°	- 11°	- 17°	- 22°
<b>Angulation</b>	0°	0°	+ 7°	0°	0°	0°	0°	+ 7°	0°	0°
<b>In/Out</b>	0,7 mm	0,7 mm	0,7 mm	1,3 mm	1,3 mm	1,3 mm	1,3 mm	0,7 mm	0,7 mm	0,7 mm
<b>Width</b>	3,1 mm	3,1 mm	3,1 mm	2,4 mm	2,4 mm	2,4 mm	2,4 mm	3,1 mm	3,1 mm	3,1 mm
<b>REF</b>	<b>722-301-45</b>	<b>722-301-44</b>	<b>722-341-43</b>	<b>722-301-42</b>	<b>722-301-41</b>	<b>722-301-31</b>	<b>722-301-32</b>	<b>722-341-33</b>	<b>722-301-34</b>	<b>722-301-35</b>
<b>Quantity</b>	10 pieces	10 pieces	10 pieces	10 pieces	10 pieces	10 pieces	10 pieces	10 pieces	10 pieces	10 pieces

### Assortments:

1 case	20 brackets	<b>REF 722-301-01</b>
10 cases	200 brackets	<b>REF 722-301-10</b>
50 cases	1.000 brackets	<b>REF 722-301-50</b>

### Note:

Other brackets with Roth values see single packs.

## Roth 22

Slot: 0,56 x 0,76 mm / 22 x 30 · Hook on cuspid, 1st bicuspid and 2nd bicuspid brackets

<b>Torque</b>	- 7°	- 7°	- 2°	+ 8°	+ 12°	+ 12°	+ 8°	- 2°	- 7°	- 7°
<b>Angulation</b>	0°	0°	+ 13°	+ 9°	+ 5°	+ 5°	+ 9°	+ 13°	0°	0°
<b>In/Out</b>	0,7 mm	0,7 mm	0,7 mm	1,3 mm	0,7 mm	0,7 mm	1,3 mm	0,7 mm	0,7 mm	0,7 mm
<b>Width</b>	3,1 mm	3,1 mm	3,1 mm	3,0 mm	3,4 mm	3,4 mm	3,0 mm	3,1 mm	3,1 mm	3,1 mm
<b>REF</b>	<b>722-341-15</b>	<b>722-341-14</b>	<b>722-341-13</b>	<b>722-301-12</b>	<b>722-301-11</b>	<b>722-301-21</b>	<b>722-301-22</b>	<b>722-341-23</b>	<b>722-341-24</b>	<b>722-341-25</b>
<b>Quantity</b>	10 pieces	10 pieces	10 pieces	10 pieces	10 pieces	10 pieces	10 pieces	10 pieces	10 pieces	10 pieces

CE 0483

Even easier bracket identification with FDI-marking on the base!

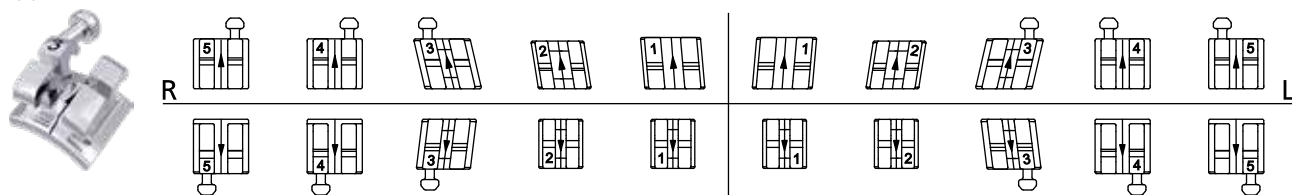

<b>Torque</b>	- 22°	- 17°	- 11°	- 1°	- 1°	- 1°	- 1°	- 11°	- 17°	- 22°
<b>Angulation</b>	0°	0°	+ 7°	0°	0°	0°	0°	+ 7°	0°	0°
<b>In/Out</b>	0,7 mm	0,7 mm	0,7 mm	1,3 mm	1,3 mm	1,3 mm	1,3 mm	0,7 mm	0,7 mm	0,7 mm
<b>Width</b>	3,1 mm	3,1 mm	3,1 mm	2,4 mm	2,4 mm	2,4 mm	2,4 mm	3,1 mm	3,1 mm	3,1 mm
<b>REF</b>	<b>722-341-45</b>	<b>722-341-44</b>	<b>722-341-43</b>	<b>722-301-42</b>	<b>722-301-41</b>	<b>722-301-31</b>	<b>722-301-32</b>	<b>722-341-33</b>	<b>722-341-34</b>	<b>722-341-35</b>
<b>Quantity</b>	10 pieces	10 pieces	10 pieces	10 pieces	10 pieces	10 pieces	10 pieces	10 pieces	10 pieces	10 pieces

### Assortments:

1 case	20 brackets	<b>REF 722-341-01</b>
10 cases	200 brackets	<b>REF 722-341-10</b>
50 cases	1.000 brackets	<b>REF 722-341-50</b>

### Note:

Other brackets with Roth values see single packs.

Maxillary Mandibular Maxillary + Mandibular / Assortments

# equilibrium® 2 / Assortments

## McLaughlin-Bennett-Trevisi\*\* 18

Slot: 0,46 x 0,76 mm / 18 x 30 · Cuspid brackets with hook

<b>Torque</b>	- 7°	- 7°	0°	+ 10°	+ 17°	+ 17°	+ 10°	0°	- 7°	- 7°
<b>Angulation</b>	0°	0°	+ 8°	+ 8°	+ 4°	+ 4°	+ 8°	+ 8°	0°	0°
<b>In/Out</b>	1,2 mm	0,7 mm	0,7 mm	1,3 mm	0,7 mm	0,7 mm	1,3 mm	0,7 mm	0,7 mm	1,2 mm
<b>Width</b>	3,1 mm	3,1 mm	3,1 mm	3,0 mm	3,4 mm	3,4 mm	3,0 mm	3,1 mm	3,1 mm	3,1 mm
<b>REF</b>	<b>718-302-15</b>	<b>718-302-14</b>	<b>718-342-13</b>	<b>718-302-12</b>	<b>718-302-11</b>	<b>718-302-21</b>	<b>718-302-22</b>	<b>718-342-23</b>	<b>718-302-24</b>	<b>718-302-25</b>
<b>Quantity</b>	10 pieces	10 pieces	10 pieces	10 pieces	10 pieces	10 pieces	10 pieces	10 pieces	10 pieces	10 pieces

CE 0483

Even easier bracket identification with FDI-marking on the base!

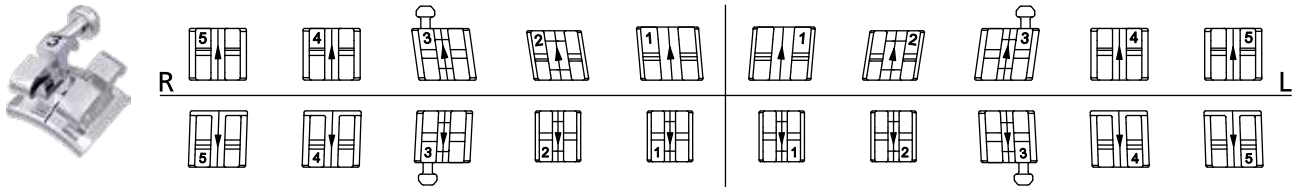

<b>Torque</b>	- 17°	- 12°	0°	- 6°	- 6°	- 6°	- 6°	0°	- 12°	- 17°
<b>Angulation</b>	+ 2°	+ 2°	+ 3°	0°	0°	0°	0°	+ 3°	+ 2°	+ 2°
<b>In/Out</b>	0,7 mm	0,7 mm	0,7 mm	1,3 mm	1,3 mm	1,3 mm	1,3 mm	0,7 mm	0,7 mm	0,7 mm
<b>Width</b>	3,1 mm	3,1 mm	3,1 mm	2,4 mm	2,4 mm	2,4 mm	2,4 mm	3,1 mm	3,1 mm	3,1 mm
<b>REF</b>	<b>718-302-45</b>	<b>718-302-44</b>	<b>718-342-43</b>	<b>718-302-42</b>	<b>718-302-41</b>	<b>718-302-31</b>	<b>718-302-32</b>	<b>718-342-33</b>	<b>718-302-34</b>	<b>718-302-35</b>
<b>Quantity</b>	10 pieces	10 pieces	10 pieces	10 pieces	10 pieces	10 pieces	10 pieces	10 pieces	10 pieces	10 pieces

### Assortments:

1 case	20 brackets	<b>REF 718-302-01</b>
10 cases	200 brackets	<b>REF 718-302-10</b>
50 cases	1.000 brackets	<b>REF 718-302-50</b>

\*\* The Dentaaurum version of this prescription is not claimed to be a duplication of any other, nor does Dentaaurum imply that it is endorsed in any way by Drs. McLaughlin, Bennett and Trevisi.

## McLaughlin-Bennett-Trevisi\*\* 18

Slot: 0,46 x 0,76 mm / 18 x 30 · Hook on cuspid, 1st bicuspid and 2nd bicuspid brackets

<b>Torque</b>	- 7°	- 7°	0°	+ 10°	+ 17°	+ 17°	+ 10°	0°	- 7°	- 7°
<b>Angulation</b>	0°	0°	+ 8°	+ 8°	+ 4°	+ 4°	+ 8°	+ 8°	0°	0°
<b>In/Out</b>	1,2 mm	0,7 mm	0,7 mm	1,3 mm	0,7 mm	0,7 mm	1,3 mm	0,7 mm	0,7 mm	1,2 mm
<b>Width</b>	3,1 mm	3,1 mm	3,1 mm	3,0 mm	3,4 mm	3,4 mm	3,0 mm	3,1 mm	3,1 mm	3,1 mm
<b>REF</b>	<b>718-342-15</b>	<b>718-342-14</b>	<b>718-342-13</b>	<b>718-302-12</b>	<b>718-302-11</b>	<b>718-302-21</b>	<b>718-302-22</b>	<b>718-342-23</b>	<b>718-342-24</b>	<b>718-342-25</b>
<b>Quantity</b>	10 pieces	10 pieces	10 pieces	10 pieces	10 pieces	10 pieces	10 pieces	10 pieces	10 pieces	10 pieces

CE 0483

Even easier bracket identification with FDI-marking on the base!

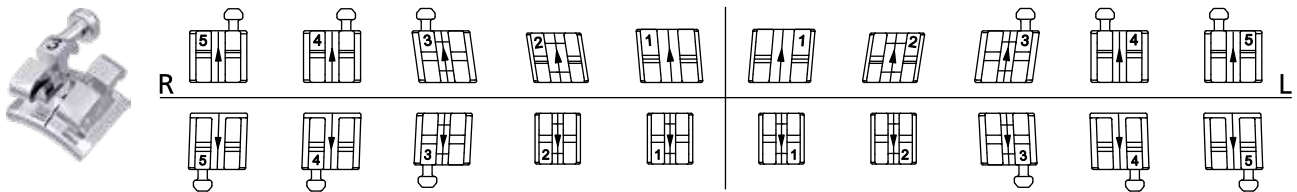

<b>Torque</b>	- 17°	- 12°	0°	- 6°	- 6°	- 6°	- 6°	0°	- 12°	- 17°
<b>Angulation</b>	+ 2°	+ 2°	+ 3°	0°	0°	0°	0°	+ 3°	+ 2°	+ 2°
<b>In/Out</b>	0,7 mm	0,7 mm	0,7 mm	1,3 mm	1,3 mm	1,3 mm	1,3 mm	0,7 mm	0,7 mm	0,7 mm
<b>Width</b>	3,1 mm	3,1 mm	3,1 mm	2,4 mm	2,4 mm	2,4 mm	2,4 mm	3,1 mm	3,1 mm	3,1 mm
<b>REF</b>	<b>718-342-45</b>	<b>718-342-44</b>	<b>718-342-43</b>	<b>718-302-42</b>	<b>718-302-41</b>	<b>718-302-31</b>	<b>718-302-32</b>	<b>718-342-33</b>	<b>718-342-34</b>	<b>718-342-35</b>
<b>Quantity</b>	10 pieces	10 pieces	10 pieces	10 pieces	10 pieces	10 pieces	10 pieces	10 pieces	10 pieces	10 pieces

### Assortments:

1 case	20 brackets	<b>REF 718-342-01</b>
10 cases	200 brackets	<b>REF 718-342-10</b>
50 cases	1.000 brackets	<b>REF 718-342-50</b>

\*\* The Dentaaurum version of this prescription is not claimed to be a duplication of any other, nor does Dentaaurum imply that it is endorsed in any way by Drs. McLaughlin, Bennett and Trevisi.

# equilibrium® 2 / Assortments

## McLaughlin-Bennett-Trevisi\*\* 22

Slot: 0,56 x 0,76 mm / 22 x 30 · Cuspid brackets with hook

<b>Torque</b>	- 7°	- 7°	0°	+ 10°	+ 17°	+ 17°	+ 10°	0°	- 7°	- 7°
<b>Angulation</b>	0°	0°	+ 8°	+ 8°	+ 4°	+ 4°	+ 8°	+ 8°	0°	0°
<b>In/Out</b>	1,2 mm	0,7 mm	0,7 mm	1,3 mm	0,7 mm	0,7 mm	1,3 mm	0,7 mm	0,7 mm	1,2 mm
<b>Width</b>	3,1 mm	3,1 mm	3,1 mm	3,0 mm	3,4 mm	3,4 mm	3,0 mm	3,1 mm	3,1 mm	3,1 mm
<b>REF</b>	<b>722-302-15</b>	<b>722-302-14</b>	<b>722-342-13</b>	<b>722-302-12</b>	<b>722-302-11</b>	<b>722-302-21</b>	<b>722-302-22</b>	<b>722-342-23</b>	<b>722-302-24</b>	<b>722-302-25</b>
<b>Quantity</b>	10 pieces	10 pieces	10 pieces	10 pieces	10 pieces	10 pieces	10 pieces	10 pieces	10 pieces	10 pieces

CE 0483

Even easier bracket identification with FDI-marking on the base!

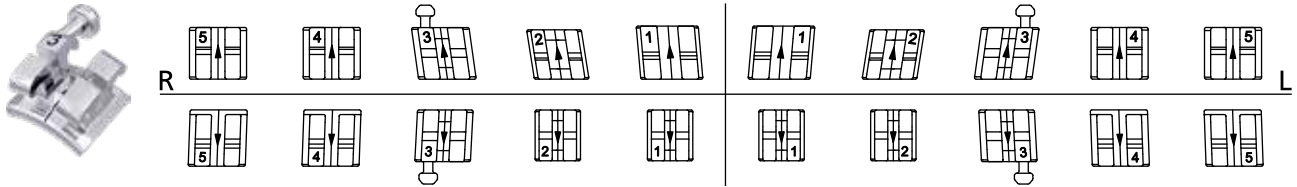

<b>Torque</b>	- 17°	- 12°	0°	- 6°	- 6°	- 6°	- 6°	0°	- 12°	- 17°
<b>Angulation</b>	+ 2°	+ 2°	+ 3°	0°	0°	0°	0°	+ 3°	+ 2°	+ 2°
<b>In/Out</b>	0,7 mm	0,7 mm	0,7 mm	1,3 mm	1,3 mm	1,3 mm	1,3 mm	0,7 mm	0,7 mm	0,7 mm
<b>Width</b>	3,1 mm	3,1 mm	3,1 mm	2,4 mm	2,4 mm	2,4 mm	2,4 mm	3,1 mm	3,1 mm	3,1 mm
<b>REF</b>	<b>722-302-45</b>	<b>722-302-44</b>	<b>722-342-43</b>	<b>722-302-42</b>	<b>722-302-41</b>	<b>722-302-31</b>	<b>722-302-32</b>	<b>722-342-33</b>	<b>722-302-34</b>	<b>722-302-35</b>
<b>Quantity</b>	10 pieces	10 pieces	10 pieces	10 pieces	10 pieces	10 pieces	10 pieces	10 pieces	10 pieces	10 pieces

### Assortments:

1 case	20 brackets	<b>REF 722-302-01</b>
10 cases	200 brackets	<b>REF 722-302-10</b>
50 cases	1.000 brackets	<b>REF 722-302-50</b>

\*\* The Dentaaurum version of this prescription is not claimed to be a duplication of any other, nor does Dentaaurum imply that it is endorsed in any way by Drs. McLaughlin, Bennett and Trevisi.

## McLaughlin-Bennett-Trevisi\*\* 22

Slot: 0,56 x 0,76 mm / 22 x 30 · Hook on cuspid, 1st bicuspid and 2nd bicuspid brackets

<b>Torque</b>	- 7°	- 7°	0°	+ 10°	+ 17°	+ 17°	+ 10°	0°	- 7°	- 7°
<b>Angulation</b>	0°	0°	+ 8°	+ 8°	+ 4°	+ 4°	+ 8°	+ 8°	0°	0°
<b>In/Out</b>	1,2 mm	0,7 mm	0,7 mm	1,3 mm	0,7 mm	0,7 mm	1,3 mm	0,7 mm	0,7 mm	1,2 mm
<b>Width</b>	3,1 mm	3,1 mm	3,1 mm	3,0 mm	3,4 mm	3,4 mm	3,0 mm	3,1 mm	3,1 mm	3,1 mm
<b>REF</b>	<b>722-342-15</b>	<b>722-342-14</b>	<b>722-342-13</b>	<b>722-302-12</b>	<b>722-302-11</b>	<b>722-302-21</b>	<b>722-302-22</b>	<b>722-342-23</b>	<b>722-342-24</b>	<b>722-342-25</b>
<b>Quantity</b>	10 pieces	10 pieces	10 pieces	10 pieces	10 pieces	10 pieces	10 pieces	10 pieces	10 pieces	10 pieces

CE 0483

Even easier bracket identification with FDI-marking on the base!

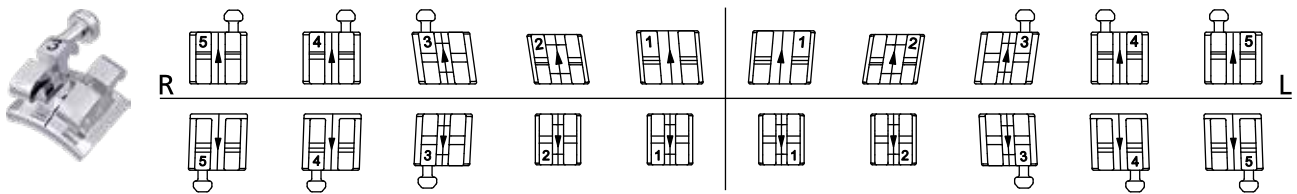

<b>Torque</b>	- 17°	- 12°	0°	- 6°	- 6°	- 6°	- 6°	0°	- 12°	- 17°
<b>Angulation</b>	+ 2°	+ 2°	+ 3°	0°	0°	0°	0°	+ 3°	+ 2°	+ 2°
<b>In/Out</b>	0,7 mm	0,7 mm	0,7 mm	1,3 mm	1,3 mm	1,3 mm	1,3 mm	0,7 mm	0,7 mm	0,7 mm
<b>Width</b>	3,1 mm	3,1 mm	3,1 mm	2,4 mm	2,4 mm	2,4 mm	2,4 mm	3,1 mm	3,1 mm	3,1 mm
<b>REF</b>	<b>722-342-45</b>	<b>722-342-44</b>	<b>722-342-43</b>	<b>722-302-42</b>	<b>722-302-41</b>	<b>722-302-31</b>	<b>722-302-32</b>	<b>722-342-33</b>	<b>722-342-34</b>	<b>722-342-35</b>
<b>Quantity</b>	10 pieces	10 pieces	10 pieces	10 pieces	10 pieces	10 pieces	10 pieces	10 pieces	10 pieces	10 pieces

### Assortments:

1 case	20 brackets	<b>REF 722-342-01</b>
10 cases	200 brackets	<b>REF 722-342-10</b>
50 cases	1.000 brackets	<b>REF 722-342-50</b>

\*\* The Dentaaurum version of this prescription is not claimed to be a duplication of any other, nor does Dentaaurum imply that it is endorsed in any way by Drs. McLaughlin, Bennett and Trevisi.

Maxillary Mandibular Maxillary + Mandibular / Assortments



# equilibrium® 2 / Assortments

## Ricketts® Universal 18

Slot: 0,46 x 0,76 mm / 18 x 30 · without hook

<b>Torque</b>	0°	0°	+ 7°	+ 14°	+ 22°	+ 22°	+ 14°	+ 7°	0°	0°
<b>Angulation</b>	0°	0°	+ 5°	+ 8°	0°	0°	+ 8°	+ 5°	0°	0°
<b>In/Out</b>	0,7 mm	0,7 mm	0,7 mm	0,7 mm	0,7 mm	0,7 mm	0,7 mm	0,7 mm	0,7 mm	0,7 mm
<b>Width</b>	3,1 mm	3,1 mm	3,1 mm	2,9 mm	3,3 mm	3,3 mm	2,9 mm	3,1 mm	3,1 mm	3,1 mm
<b>REF</b>	<b>718-303-15</b>	<b>718-303-14</b>	<b>718-303-13</b>	<b>718-303-12</b>	<b>718-303-11</b>	<b>718-303-21</b>	<b>718-303-22</b>	<b>718-303-23</b>	<b>718-303-24</b>	<b>718-303-25</b>
<b>Quantity</b>	10 pieces	10 pieces	10 pieces	10 pieces	10 pieces	10 pieces	10 pieces	10 pieces	10 pieces	10 pieces

CE 0483

Even easier bracket identification with FDI-marking on the base!

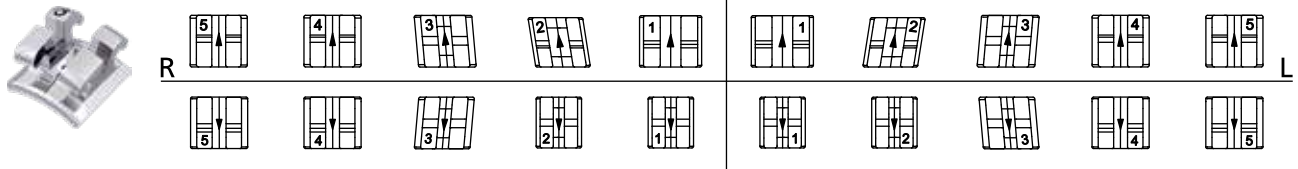

<b>Torque</b>	0°	0°	+ 7°	0°	0°	0°	0°	+ 7°	0°	0°
<b>Angulation</b>	0°	0°	+ 5°	0°	0°	0°	0°	+ 5°	0°	0°
<b>In/Out</b>	0,7 mm	0,7 mm	0,7 mm	0,7 mm	0,7 mm	0,7 mm	0,7 mm	0,7 mm	0,7 mm	0,7 mm
<b>Width</b>	3,1 mm	3,1 mm	2,7 mm	2,3 mm	2,3 mm	2,3 mm	2,3 mm	2,7 mm	3,1 mm	3,1 mm
<b>REF</b>	<b>718-303-45</b>	<b>718-303-44</b>	<b>718-303-43</b>	<b>718-303-42</b>	<b>718-303-41</b>	<b>718-303-31</b>	<b>718-303-32</b>	<b>718-303-33</b>	<b>718-303-34</b>	<b>718-303-35</b>
<b>Quantity</b>	10 pieces	10 pieces	10 pieces	10 pieces	10 pieces	10 pieces	10 pieces	10 pieces	10 pieces	10 pieces

### Assortments:

1 case	20 brackets	<b>REF 718-303-01</b>
10 cases	200 brackets	<b>REF 718-303-10</b>
50 cases	1.000 brackets	<b>REF 718-303-50</b>

### Note:

Other brackets with Ricketts® Universal values see single packs.

## Standard Edgewise 18

Slot: 0,46 x 0,76 mm / 18 x 30 · without hook

<b>Torque</b>	0°	0°	0°	0°	0°	0°	0°	0°	0°	0°
<b>Angulation</b>	0°	0°	0°	0°	0°	0°	0°	0°	0°	0°
<b>In/Out</b>	0,7 mm	0,7 mm	0,7 mm	0,7 mm	0,7 mm	0,7 mm	0,7 mm	0,7 mm	0,7 mm	0,7 mm
<b>Width</b>	3,1 mm	3,1 mm	3,1 mm	2,9 mm	3,3 mm	3,3 mm	2,9 mm	3,1 mm	3,1 mm	3,1 mm
<b>REF</b>	<b>718-305-15</b>	<b>718-305-14</b>	<b>718-305-13</b>	<b>718-305-12</b>	<b>718-305-11</b>	<b>718-305-21</b>	<b>718-305-22</b>	<b>718-305-23</b>	<b>718-305-24</b>	<b>718-305-25</b>
<b>Quantity</b>	10 pieces	10 pieces	10 pieces	10 pieces	10 pieces	10 pieces	10 pieces	10 pieces	10 pieces	10 pieces

CE 0483

Even easier bracket identification with FDI-marking on the base!

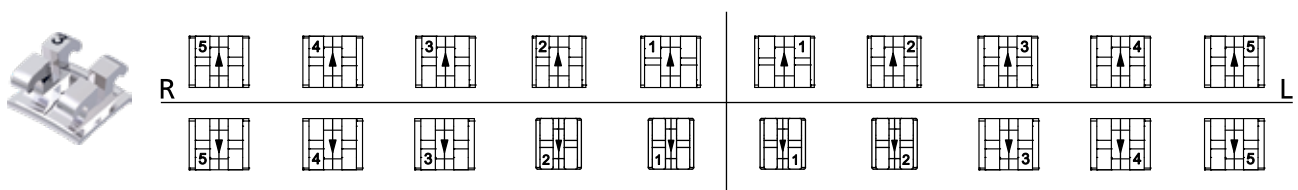

<b>Torque</b>	0°	0°	0°	0°	0°	0°	0°	0°	0°	0°
<b>Angulation</b>	0°	0°	0°	0°	0°	0°	0°	0°	0°	0°
<b>In/Out</b>	0,7 mm	0,7 mm	0,7 mm	0,7 mm	0,7 mm	0,7 mm	0,7 mm	0,7 mm	0,7 mm	0,7 mm
<b>Width</b>	3,1 mm	3,1 mm	3,1 mm	2,3 mm	2,3 mm	2,3 mm	2,3 mm	3,1 mm	3,1 mm	3,1 mm
<b>REF</b>	<b>718-305-45</b>	<b>718-305-44</b>	<b>718-305-43</b>	<b>718-305-42</b>	<b>718-305-41</b>	<b>718-305-31</b>	<b>718-305-32</b>	<b>718-305-33</b>	<b>718-305-34</b>	<b>718-305-35</b>
<b>Quantity</b>	10 pieces	10 pieces	10 pieces	10 pieces	10 pieces	10 pieces	10 pieces	10 pieces	10 pieces	10 pieces

### Assortments:

1 case	20 brackets	<b>REF 718-305-01</b>
10 cases	200 brackets	<b>REF 718-305-10</b>
50 cases	1.000 brackets	<b>REF 718-305-50</b>

Maxillary

Mandibular

Maxillary + Mandibular / Assortments

**Standard Edgewise 22**

Slot: 0,56 x 0,76 mm / 22 x 30 · without hook

<b>Torque</b>	0°	0°	0°	0°	0°	0°	0°	0°	0°	0°
<b>Angulation</b>	0°	0°	0°	0°	0°	0°	0°	0°	0°	0°
<b>In/Out</b>	0,7 mm	0,7 mm	0,7 mm	0,7 mm	0,7 mm	0,7 mm	0,7 mm	0,7 mm	0,7 mm	0,7 mm
<b>Width</b>	3,1 mm	3,1 mm	3,1 mm	2,9 mm	3,3 mm	3,3 mm	2,9 mm	3,1 mm	3,1 mm	3,1 mm
<b>REF</b>	<b>722-305-15</b>	<b>722-305-14</b>	<b>722-305-13</b>	<b>722-305-12</b>	<b>722-305-11</b>	<b>722-305-21</b>	<b>722-305-22</b>	<b>722-305-23</b>	<b>722-305-24</b>	<b>722-305-25</b>
<b>Quantity</b>	10 pieces	10 pieces	10 pieces	10 pieces	10 pieces	10 pieces	10 pieces	10 pieces	10 pieces	10 pieces

CE 0483

Even easier bracket identification with FDI-marking on the base!

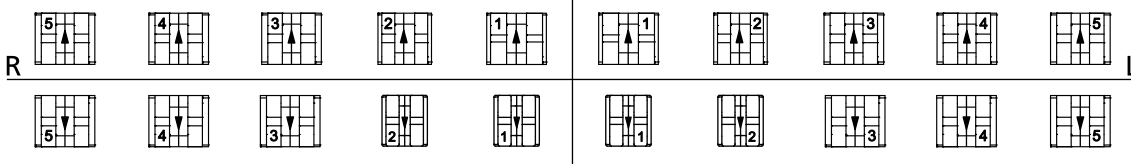

<b>Torque</b>	0°	0°	0°	0°	0°	0°	0°	0°	0°	0°
<b>Angulation</b>	0°	0°	0°	0°	0°	0°	0°	0°	0°	0°
<b>In/Out</b>	0,7 mm	0,7 mm	0,7 mm	0,7 mm	0,7 mm	0,7 mm	0,7 mm	0,7 mm	0,7 mm	0,7 mm
<b>Width</b>	3,1 mm	3,1 mm	3,1 mm	2,3 mm	2,3 mm	2,3 mm	2,3 mm	3,1 mm	3,1 mm	3,1 mm
<b>REF</b>	<b>722-305-45</b>	<b>722-305-44</b>	<b>722-305-43</b>	<b>722-305-42</b>	<b>722-305-41</b>	<b>722-305-31</b>	<b>722-305-32</b>	<b>722-305-33</b>	<b>722-305-34</b>	<b>722-305-35</b>
<b>Quantity</b>	10 pieces	10 pieces	10 pieces	10 pieces	10 pieces	10 pieces	10 pieces	10 pieces	10 pieces	10 pieces

**Assortments:**

1 case	20 brackets	<b>REF 722-305-01</b>
10 cases	200 brackets	<b>REF 722-305-10</b>
50 cases	1.000 brackets	<b>REF 722-305-50</b>

**DENTAURUM**  
**ONLINE SHOP**  
[shop.dentaurum.com](http://shop.dentaurum.com)



## equilibrium® 2 / Single packs – bonding technique



### Roth 18/22

Teeth	Torque	Angulation	In/Out	Hook	Width	REF (18)	REF (22)	Quantity
13	- 2°	+ 13°	0,7 mm		3,1 mm		<b>722-301-13</b>	10 pieces
23	- 2°	+ 13°	0,7 mm		3,1 mm		<b>722-301-23</b>	10 pieces



Teeth	Torque	Angulation	In/Out	Hook	Width	REF (18)	REF (22)	Quantity
43	- 11°	+ 7°	0,7 mm		3,1 mm	<b>718-301-43</b>	<b>722-301-43</b>	10 pieces
33	- 11°	+ 7°	0,7 mm		3,1 mm	<b>718-301-33</b>	<b>722-301-33</b>	10 pieces

CE 0483

Even easier bracket identification with FDI-marking on the base!  
Slot 18: 0,46 x 0,76 mm / 18 x 30  
Slot 22: 0,56 x 0,76 mm / 22 x 30



### Ricketts® Universal 18

Teeth	Torque	Angulation	In/Out	Hook	Width	REF (18)	REF (22)	Quantity
13	+ 7°	+ 5°	0,7 mm	•	3,1 mm	<b>718-343-13</b>		10 pieces
23	+ 7°	+ 5°	0,7 mm	•	3,1 mm	<b>718-343-23</b>		10 pieces



Teeth	Torque	Angulation	In/Out	Hook	Width	REF (18)	REF (22)	Quantity
43	+ 7°	+ 5°	0,7 mm	•	2,7 mm	<b>718-343-43</b>		10 pieces
33	+ 7°	+ 5°	0,7 mm	•	2,7 mm	<b>718-343-33</b>		10 pieces

CE 0483

Even easier bracket identification with FDI-marking on the base!  
Slot 18: 0,46 x 0,76 mm / 18 x 30

## equilibrium® 2 / Single packs – banding technique



### Roth 18/22

Teeth	Torque	Angulation	In/Out	Hook	Width	REF (18)	REF (22)	Quantity
13	- 2°	+ 13°	0,7 mm		3,1 mm	790-259-02	790-263-02	10 pieces
13	- 2°	+ 13°	0,7 mm	•	3,1 mm	790-204-02	790-216-02	10 pieces
23	- 2°	+ 13°	0,7 mm		3,1 mm	790-260-02	790-264-02	10 pieces
23	- 2°	+ 13°	0,7 mm	•	3,1 mm	790-205-02	790-217-02	10 pieces



Teeth	Torque	Angulation	In/Out	Hook	Width	REF (18)	REF (22)	Quantity
42-41/31-32	- 1°	0°	1,3 mm		2,4 mm	790-207-02	790-219-02	10 pieces
43	- 11°	+ 7°	0,7 mm		3,1 mm	790-261-02	790-265-02	10 pieces
43	- 11°	+ 7°	0,7 mm	•	3,1 mm	790-208-02	790-220-02	10 pieces
33	- 11°	+ 7°	0,7 mm		3,1 mm	790-262-02	790-266-02	10 pieces
33	- 11°	+ 7°	0,7 mm	•	3,1 mm	790-209-02	790-221-02	10 pieces
44/34	- 17°	0°	0,7 mm		3,1 mm	790-210-02	790-222-02	10 pieces
44	- 17°	0°	0,7 mm	•	3,1 mm	790-251-02	790-255-02	10 pieces
34	- 17°	0°	0,7 mm	•	3,1 mm	790-252-02	790-256-02	10 pieces
45/35	- 22°	0°	0,7 mm		3,1 mm	790-211-02	790-223-02	10 pieces
45	- 22°	0°	0,7 mm	•	3,1 mm	790-253-02	790-257-02	10 pieces
35	- 22°	0°	0,7 mm	•	3,1 mm	790-254-02	790-258-02	10 pieces

CE 0483

Slot 18: 0,46 x 0,76 mm / 18 x 30  
Slot 22: 0,56 x 0,76 mm / 22 x 30



### Roth, McLaughlin-Bennett-Trevisi\*\* 18/22

Teeth	Torque	Angulation	In/Out	Hook	Width	REF (18)	REF (22)	Quantity
15-14/24-25	- 7°	0°	0,7 mm		3,1 mm	790-206-02	790-218-02	10 pieces
15-14	- 7°	0°	0,7 mm	•	3,1 mm	790-249-02	790-243-02	10 pieces
24-25	- 7°	0°	0,7 mm	•	3,1 mm	790-250-02	790-244-02	10 pieces

CE 0483

Slot 18: 0,46 x 0,76 mm / 18 x 30  
Slot 22: 0,56 x 0,76 mm / 22 x 30

\*\* The Dentaforum version of this prescription is not claimed to be a duplication of any other, nor does Dentaforum imply that it is endorsed in any way by Drs. McLaughlin, Bennett and Trevisi.

# equilibrium® 2 / Single packs – banding technique



## McLaughlin-Bennett-Trevisi\*\* 18/22

Teeth	Torque	Angulation	In/Out	Hook	Width	REF (18)	REF (22)	Quantity
13	0°	+ 8°	0,7 mm	•	3,1 mm	790-274-02	790-228-02	10 pieces
13	- 7°	+ 8°	0,7 mm	•	3,1 mm		790-230-02	10 pieces
23	0°	+ 8°	0,7 mm	•	3,1 mm	790-275-02	790-229-02	10 pieces
23	- 7°	+ 8°	0,7 mm	•	3,1 mm		790-231-02	10 pieces
15/25	- 7°	0°	1,2 mm	•	3,1 mm	790-276-02	790-267-02	10 pieces
15	- 7°	0°	1,2 mm	•	3,1 mm	790-284-02	790-268-02	10 pieces
25	- 7°	0°	1,2 mm	•	3,1 mm	790-285-02	790-269-02	10 pieces



Teeth	Torque	Angulation	In/Out	Hook	Width	REF (18)	REF (22)	Quantity
42-41/31-32	- 6°	0°	1,3 mm	•	2,4 mm	790-277-02	790-233-02	10 pieces
43	0°	+ 3°	0,7 mm	•	3,1 mm	790-278-02	790-234-02	10 pieces
43	- 6°	+ 3°	0,7 mm	•	3,1 mm		790-236-02	10 pieces
33	0°	+ 3°	0,7 mm	•	3,1 mm	790-279-02	790-235-02	10 pieces
33	- 6°	+ 3°	0,7 mm	•	3,1 mm		790-237-02	10 pieces
44	- 12°	+ 2°	0,7 mm	•	3,1 mm	790-280-02	790-239-02	10 pieces
44	- 12°	+ 2°	0,7 mm	•	3,1 mm	790-286-02	790-245-02	10 pieces
34	- 12°	+ 2°	0,7 mm	•	3,1 mm	790-281-02	790-240-02	10 pieces
34	- 12°	+ 2°	0,7 mm	•	3,1 mm	790-287-02	790-246-02	10 pieces
45	- 17°	+ 2°	0,7 mm	•	3,1 mm	790-282-02	790-241-02	10 pieces
45	- 17°	+ 2°	0,7 mm	•	3,1 mm	790-288-02	790-247-02	10 pieces
35	- 17°	+ 2°	0,7 mm	•	3,1 mm	790-283-02	790-242-02	10 pieces
35	- 17°	+ 2°	0,7 mm	•	3,1 mm	790-289-02	790-248-02	10 pieces

© 0483

Slot 18: 0,46 x 0,76 mm / 18 x 30  
Slot 22: 0,56 x 0,76 mm / 22 x 30

\*\* The Dentaform version of this prescription is not claimed to be a duplication of any other, nor does Dentaform imply that it is endorsed in any way by Drs. McLaughlin, Bennett and Trevisi.



## Standard Edgewise 18/22

Teeth	Torque	Angulation	In/Out	Hook	Width	REF (18)	REF (22)	Quantity
42-41/31-32	0°	0°	0,7 mm	•	2,4 mm	790-603-02	790-607-02	10 pieces



Teeth	Torque	Angulation	In/Out	Hook	Width	REF (18)	REF (22)	Quantity
15-13/23-25/45-43/33-35	0°	0°	0,7 mm	•	3,1 mm	790-602-02	790-606-02	10 pieces

© 0483

Slot 18: 0,46 x 0,76 mm / 18 x 30  
Slot 22: 0,56 x 0,76 mm / 22 x 30



## Individuelle Systeme 18/22

Teeth	Torque	Angulation	In/Out	Hook	Width	REF (18)	REF (22)	Quantity
13/24-25	+ 7°	0°	0,7 mm	•	3,1 mm	790-290-02		10 pieces
15-14/23	+ 7°	0°	0,7 mm	•	3,1 mm	790-291-02		10 pieces



Teeth	Torque	Angulation	In/Out	Hook	Width	REF (18)	REF (22)	Quantity
45-43	- 11°	0°	0,7 mm	•	3,1 mm		790-294-02	10 pieces
33-35	- 11°	0°	0,7 mm	•	3,1 mm		790-295-02	10 pieces

© 0483

Slot 18: 0,46 x 0,76 mm / 18 x 30  
Slot 22: 0,56 x 0,76 mm / 22 x 30

Maxillary

Mandibular

Maxillary + Mandibular / Assortments

### Roth 18

Slot: 0,46 x 0,76 mm / 18 x 30 · Cuspid brackets with hook

<b>Torque</b>	- 7°	- 7°	- 2°	+ 8°	+ 12°	+ 12°	+ 8°	- 2°	- 7°	- 7°
<b>Angulation</b>	0°	0°	+ 13°	+ 9°	+ 5°	+ 5°	+ 9°	+ 13°	0°	0°
<b>In/Out</b>	0,7 mm	0,7 mm	0,7 mm	1,3 mm	0,7 mm	0,7 mm	1,3 mm	0,7 mm	0,7 mm	0,7 mm
<b>Width</b>	3,1 mm	3,1 mm	3,1 mm	3,0 mm	3,4 mm	3,4 mm	3,0 mm	3,1 mm	3,1 mm	3,1 mm
<b>REF</b>	<b>718-501-15</b>	<b>718-501-14</b>	<b>718-541-13</b>	<b>718-501-12</b>	<b>718-501-11</b>	<b>718-501-21</b>	<b>718-501-22</b>	<b>718-541-23</b>	<b>718-501-24</b>	<b>718-501-25</b>
<b>Quantity</b>	10 pieces	10 pieces	10 pieces	10 pieces	10 pieces	10 pieces	10 pieces	10 pieces	10 pieces	10 pieces

CE 0483

Even easier bracket identification with FDI-marking on the base!

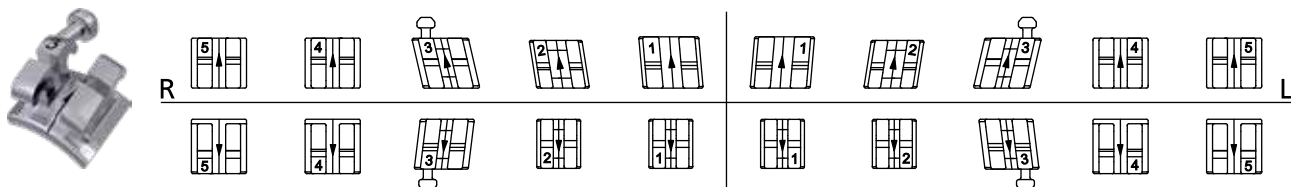

<b>Torque</b>	- 22°	- 17°	- 11°	- 1°	- 1°	- 1°	- 1°	- 11°	- 17°	- 22°
<b>Angulation</b>	0°	0°	+ 7°	0°	0°	0°	0°	+ 7°	0°	0°
<b>In/Out</b>	0,7 mm	0,7 mm	0,7 mm	1,3 mm	1,3 mm	1,3 mm	1,3 mm	0,7 mm	0,7 mm	0,7 mm
<b>Width</b>	3,1 mm	3,1 mm	3,1 mm	2,4 mm	2,4 mm	2,4 mm	2,4 mm	3,1 mm	3,1 mm	3,1 mm
<b>REF</b>	<b>718-501-45</b>	<b>718-501-44</b>	<b>718-541-43</b>	<b>718-501-42</b>	<b>718-501-41</b>	<b>718-501-31</b>	<b>718-501-32</b>	<b>718-541-33</b>	<b>718-501-34</b>	<b>718-501-35</b>
<b>Quantity</b>	10 pieces	10 pieces	10 pieces	10 pieces	10 pieces	10 pieces	10 pieces	10 pieces	10 pieces	10 pieces

**Assortments:**

1 case	20 brackets	<b>REF 718-501-01</b>
10 cases	200 brackets	<b>REF 718-501-10</b>
50 cases	1.000 brackets	<b>REF 718-501-50</b>

**Note:**

1 case assortment REF 718-501-02 is equivalent to REF 718-501-01, with additional 4 buccal tubes with vertical hook (1 x 723-028-00 / 1 x 723-032-00 / 2 x 723-026-00).

### Roth 22

Slot: 0,56 x 0,76 mm / 22 x 30 · Cuspid brackets with hook

<b>Torque</b>	- 7°	- 7°	- 2°	+ 8°	+ 12°	+ 12°	+ 8°	- 2°	- 7°	- 7°
<b>Angulation</b>	0°	0°	+ 13°	+ 9°	+ 5°	+ 5°	+ 9°	+ 13°	0°	0°
<b>In/Out</b>	0,7 mm	0,7 mm	0,7 mm	1,3 mm	0,7 mm	0,7 mm	1,3 mm	0,7 mm	0,7 mm	0,7 mm
<b>Width</b>	3,1 mm	3,1 mm	3,1 mm	3,0 mm	3,4 mm	3,4 mm	3,0 mm	3,1 mm	3,1 mm	3,1 mm
<b>REF</b>	<b>722-501-15</b>	<b>722-501-14</b>	<b>722-541-13</b>	<b>722-501-12</b>	<b>722-501-11</b>	<b>722-501-21</b>	<b>722-501-22</b>	<b>722-541-23</b>	<b>722-501-24</b>	<b>722-501-25</b>
<b>Quantity</b>	10 pieces	10 pieces	10 pieces	10 pieces	10 pieces	10 pieces	10 pieces	10 pieces	10 pieces	10 pieces

CE 0483

Even easier bracket identification with FDI-marking on the base!

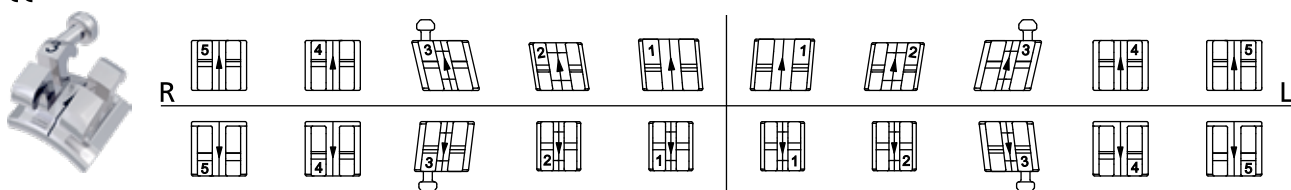

<b>Torque</b>	- 22°	- 17°	- 11°	- 1°	- 1°	- 1°	- 1°	- 11°	- 17°	- 22°
<b>Angulation</b>	0°	0°	+ 7°	0°	0°	0°	0°	+ 7°	0°	0°
<b>In/Out</b>	0,7 mm	0,7 mm	0,7 mm	1,3 mm	1,3 mm	1,3 mm	1,3 mm	0,7 mm	0,7 mm	0,7 mm
<b>Width</b>	3,1 mm	3,1 mm	3,1 mm	2,4 mm	2,4 mm	2,4 mm	2,4 mm	3,1 mm	3,1 mm	3,1 mm
<b>REF</b>	<b>722-501-45</b>	<b>722-501-44</b>	<b>722-541-43</b>	<b>722-501-42</b>	<b>722-501-41</b>	<b>722-501-31</b>	<b>722-501-32</b>	<b>722-541-33</b>	<b>722-501-34</b>	<b>722-501-35</b>
<b>Quantity</b>	10 pieces	10 pieces	10 pieces	10 pieces	10 pieces	10 pieces	10 pieces	10 pieces	10 pieces	10 pieces

**Assortments:**

1 case	20 brackets	<b>REF 722-501-01</b>
10 cases	200 brackets	<b>REF 722-501-10</b>
50 cases	1.000 brackets	<b>REF 722-501-50</b>

**Note:**

1 case assortment REF 722-501-02 is equivalent to REF 722-501-01, with additional 4 buccal tubes with vertical hook (1 x 723-029-00 / 1 x 723-033-00 / 2 x 723-027-00).



**McLaughlin-Bennett-Trevisi\*\* 18**

Slot: 0,46 x 0,76 mm / 18 x 30 · Cuspid brackets with hook

<b>Torque</b>	- 7°	- 7°	0°	+ 10°	+ 17°	+ 17°	+ 10°	0°	- 7°	- 7°
<b>Angulation</b>	0°	0°	+ 8°	+ 8°	+ 4°	+ 4°	+ 8°	+ 8°	0°	0°
<b>In/Out</b>	1,2 mm	0,7 mm	0,7 mm	1,3 mm	0,7 mm	0,7 mm	1,3 mm	0,7 mm	0,7 mm	1,2 mm
<b>Width</b>	3,1 mm	3,1 mm	3,1 mm	3,0 mm	3,4 mm	3,4 mm	3,0 mm	3,1 mm	3,1 mm	3,1 mm
<b>REF</b>	<b>718-502-15</b>	<b>718-502-14</b>	<b>718-542-13</b>	<b>718-502-12</b>	<b>718-502-11</b>	<b>718-502-21</b>	<b>718-502-22</b>	<b>718-542-23</b>	<b>718-502-24</b>	<b>718-502-25</b>
<b>Quantity</b>	10 pieces	10 pieces	10 pieces	10 pieces	10 pieces	10 pieces	10 pieces	10 pieces	10 pieces	10 pieces

CE 0483

Even easier bracket identification with FDI-marking on the base!

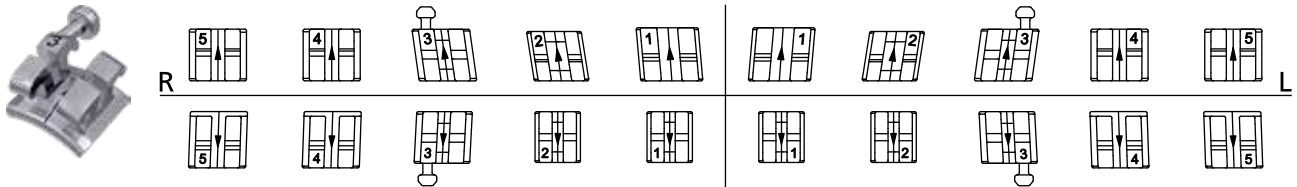

<b>Torque</b>	- 17°	- 12°	0°	- 6°	- 6°	- 6°	- 6°	0°	- 12°	- 17°
<b>Angulation</b>	+ 2°	+ 2°	+ 3°	0°	0°	0°	0°	+ 3°	+ 2°	+ 2°
<b>In/Out</b>	0,7 mm	0,7 mm	0,7 mm	1,3 mm	1,3 mm	1,3 mm	1,3 mm	0,7 mm	0,7 mm	0,7 mm
<b>Width</b>	3,1 mm	3,1 mm	3,1 mm	2,4 mm	2,4 mm	2,4 mm	2,4 mm	3,1 mm	3,1 mm	3,1 mm
<b>REF</b>	<b>718-502-45</b>	<b>718-502-44</b>	<b>718-542-43</b>	<b>718-502-42</b>	<b>718-502-41</b>	<b>718-502-31</b>	<b>718-502-32</b>	<b>718-542-33</b>	<b>718-502-34</b>	<b>718-502-35</b>
<b>Quantity</b>	10 pieces	10 pieces	10 pieces	10 pieces	10 pieces	10 pieces	10 pieces	10 pieces	10 pieces	10 pieces

**Assortments:**

1 case	20 brackets	<b>REF 718-502-01</b>
10 cases	200 brackets	<b>REF 718-502-10</b>
50 cases	1.000 brackets	<b>REF 718-502-50</b>

**Note:**

1 case assortment REF 718-502-02 is equivalent to REF 718-502-01, with additional 4 buccal tubes with vertical hook (1 x 723-028-00 / 1 x 723-032-00 / 2 x 723-030-00).

\*\* The Dentaaurum version of this prescription is not claimed to be a duplication of any other, nor does Dentaaurum imply that it is endorsed in any way by Drs. McLaughlin, Bennett and Trevisi.

**McLaughlin-Bennett-Trevisi\*\* 22**

Slot: 0,56 x 0,76 mm / 22 x 30 · Cuspid brackets with hook

<b>Torque</b>	- 7°	- 7°	0°	+ 10°	+ 17°	+ 17°	+ 10°	0°	- 7°	- 7°
<b>Angulation</b>	0°	0°	+ 8°	+ 8°	+ 4°	+ 4°	+ 8°	+ 8°	0°	0°
<b>In/Out</b>	1,2 mm	0,7 mm	0,7 mm	1,3 mm	0,7 mm	0,7 mm	1,3 mm	0,7 mm	0,7 mm	1,2 mm
<b>Width</b>	3,1 mm	3,1 mm	3,1 mm	3,0 mm	3,4 mm	3,4 mm	3,0 mm	3,1 mm	3,1 mm	3,1 mm
<b>REF</b>	<b>722-502-15</b>	<b>722-502-14</b>	<b>722-542-13</b>	<b>722-502-12</b>	<b>722-502-11</b>	<b>722-502-21</b>	<b>722-502-22</b>	<b>722-542-23</b>	<b>722-502-24</b>	<b>722-502-25</b>
<b>Quantity</b>	10 pieces	10 pieces	10 pieces	10 pieces	10 pieces	10 pieces	10 pieces	10 pieces	10 pieces	10 pieces

CE 0483

Even easier bracket identification with FDI-marking on the base!

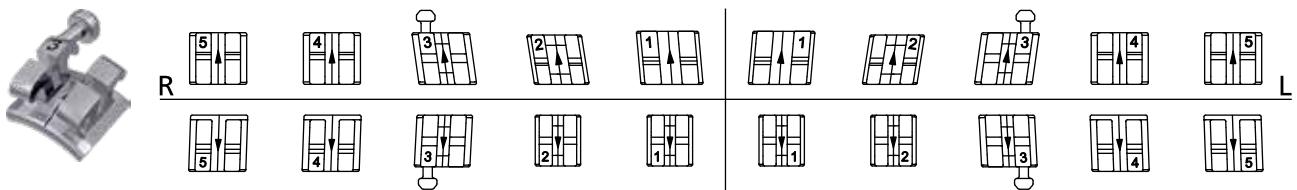

<b>Torque</b>	- 17°	- 12°	0°	- 6°	- 6°	- 6°	- 6°	0°	- 12°	- 17°
<b>Angulation</b>	+ 2°	+ 2°	+ 3°	0°	0°	0°	0°	+ 3°	+ 2°	+ 2°
<b>In/Out</b>	0,7 mm	0,7 mm	0,7 mm	1,3 mm	1,3 mm	1,3 mm	1,3 mm	0,7 mm	0,7 mm	0,7 mm
<b>Width</b>	3,1 mm	3,1 mm	3,1 mm	2,4 mm	2,4 mm	2,4 mm	2,4 mm	3,1 mm	3,1 mm	3,1 mm
<b>REF</b>	<b>722-502-45</b>	<b>722-502-44</b>	<b>722-542-43</b>	<b>722-502-42</b>	<b>722-502-41</b>	<b>722-502-31</b>	<b>722-502-32</b>	<b>722-542-33</b>	<b>722-502-34</b>	<b>722-502-35</b>
<b>Quantity</b>	10 pieces	10 pieces	10 pieces	10 pieces	10 pieces	10 pieces	10 pieces	10 pieces	10 pieces	10 pieces

**Assortments:**

1 case	20 brackets	<b>REF 722-502-01</b>
10 cases	200 brackets	<b>REF 722-502-10</b>
50 cases	1.000 brackets	<b>REF 722-502-50</b>

**Note:**

1 case assortment REF 722-502-02 is equivalent to REF 722-502-01, with additional 4 buccal tubes with vertical hook (1 x 723-029-00 / 1 x 723-033-00 / 2 x 723-031-00).

\*\* The Dentaaurum version of this prescription is not claimed to be a duplication of any other, nor does Dentaaurum imply that it is endorsed in any way by Drs. McLaughlin, Bennett and Trevisi.

# Dentaurum Group

Germany | Benelux | España | France | Italia | Switzerland | Australia | Canada | USA  
and in more than 130 countries worldwide.



DENTAURUM  
QUALITY  
WORLDWIDE  
UNIQUE

	<a href="http://www.dentaurum.com">www.dentaurum.com</a>		

Date of information: 11/18  
Subject to modifications

