



compact megapuls

Instructions for use

REF 090-620-00

D
DENTAURUM

Contents

1.	Declaration of Conformity	17
2.	Machine description	18–19
3.	Safety instructions	20
3.1.	Correct use	20
3.2.	Hazard warning symbols	20
3.3.	Warranty and liability	20
3.4.	Owner responsibility	20
3.5.	Personnel responsibility	21
3.6.	General advice on operating safety	21
3.7.	Significant dangers	21
3.8.	Disposal	21
3.9.	Delivery	22
4.	Description of the induction casting machine <i>megapuls compact</i>	22
4.1.	Function	22
4.2.	Unit construction	22
5.	Installation	23
5.1.	Positioning the machine	23
5.2.	Preparations in advance for water installation	23
5.3.	Preparations in advance for electro installation	23
6.	Operation and use	23
6.1.	Inserting the casting ring and adjusting and balancing the casting arm	23
6.2.	Starting the melting process	24
6.3.	Starting the casting process	25
6.4.	Opening the casting machine lid and removing the casting ring	25
6.5.	Switching the machine off	25
6.6.	Using the „Stop“ button	25
7.	Cleaning and maintenance	25
7.1.	Cleaning the water supply inlet	25
7.2.	Cleaning the machine	26
7.3.	Handling the melting crucible	26
8.	Correcting faults	27
9.	Spare parts	28
10.	Functional diagram	28
11.	Technical data	29

1. Declaration of Conformity

EC-Declaration of Conformity

DENTAURUM GmbH & Co. KG
Turnstr. 31
75228 Ispringen

hereby declares that the design and construction of the laboratory equipment described below, including the version marketed by us, comply with the basic regulations governing safety and health as stated in the EC Guidelines. This declaration will become invalid if the laboratory equipment is modified or altered in any way without our prior consent.

Description of unit: **Megapuls Compact**
REF 090-620-00

Type of unit: Induction Casting Machine

Start with Unit No.: 140-002 051

EC guidelines: 98/37/EC Guideline for machine

Applied unified standards: EN 746-T1/T3
EN 60204
EN 60519-1
EN 292-1
EN 292-2

Applied national standards
and technical specifications

Date and manufacturers signature: 01.01.2010
Signatory:



- i.V. Dipl. Ing. (FH) K. Merkle -
Production Manager Mechanic

2. Machine description

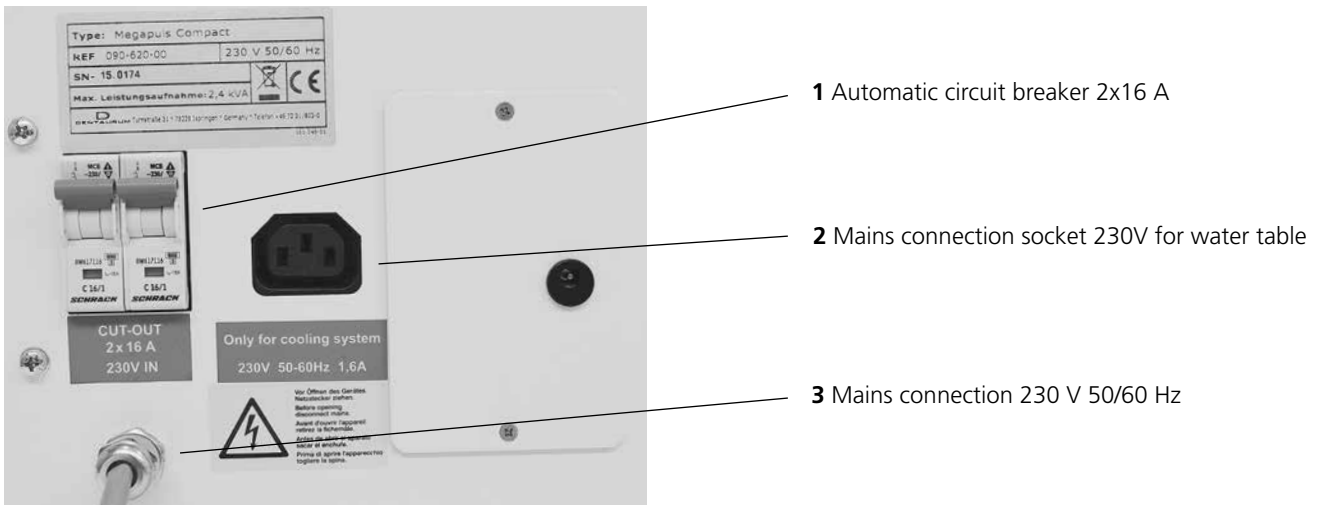

Fig. 1: Back of machine with connections

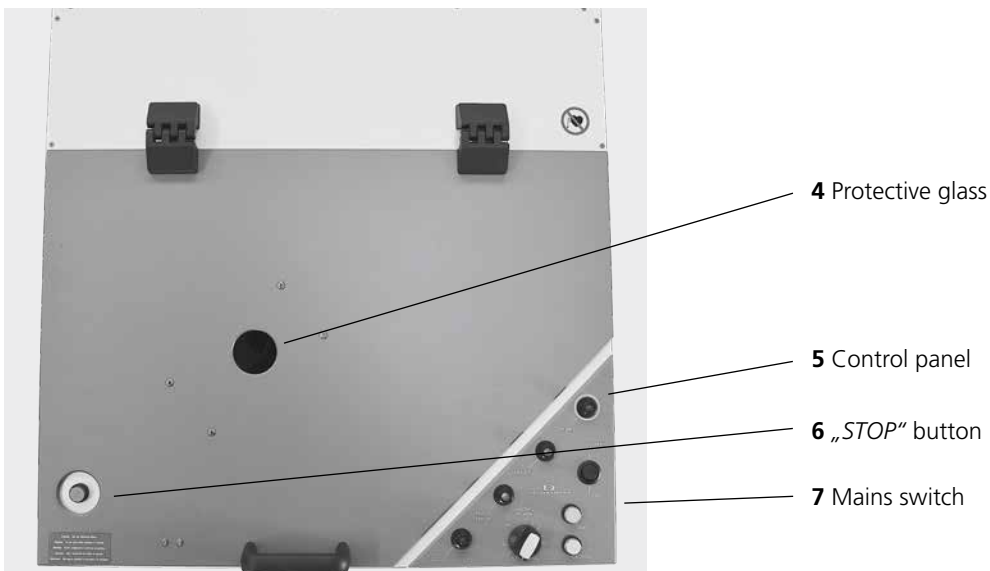

Fig. 2: View from above

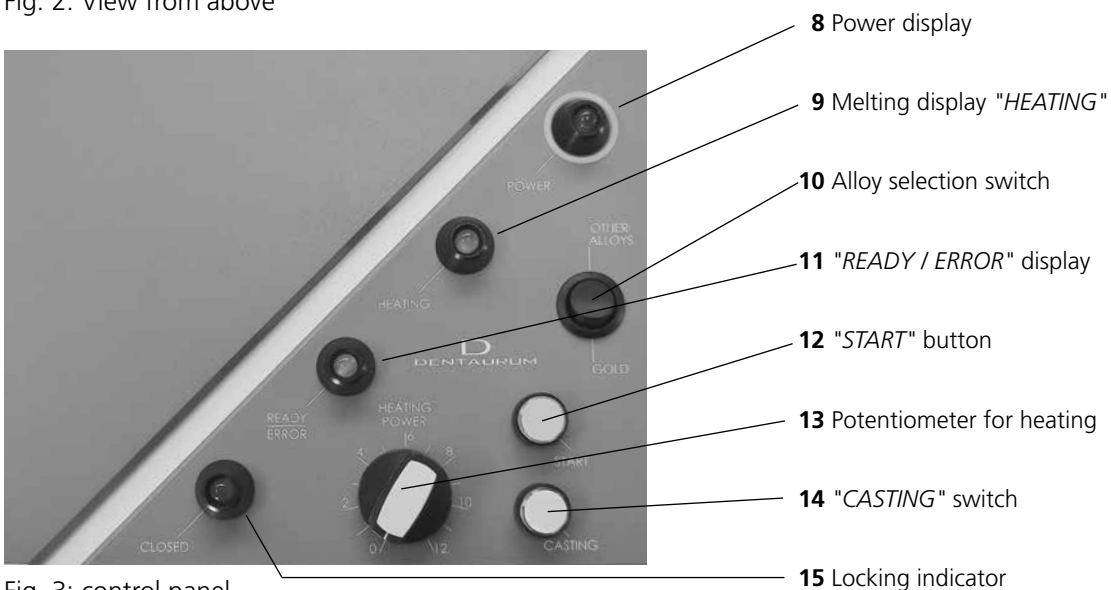

Fig. 3: control panel

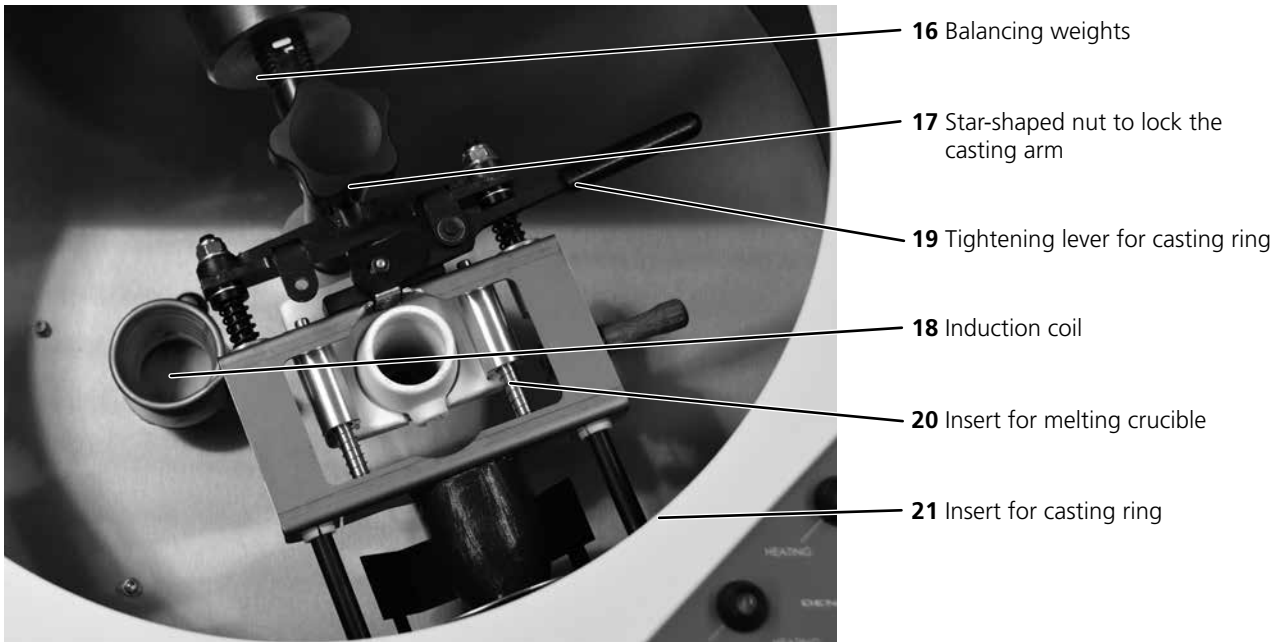



Fig. 4: Casting chamber with centrifugal arm



Fig. 5: The water filter is fitted at the fresh water inlet

3. Safety instructions

 **Caution** **Read through the instructions for installing and operating the unit carefully before switching it on.**

3.1. Correct use



The induction casting machine ***megapuls compact*** is designed solely for use in dental laboratories for melting all conventional dental metal alloys, excluding titanium and titanium alloys, and then casting by means of centrifugal force. Any other use or related improvisation of the machine is regarded as misuse. The company Dentaureum, GmbH & Co. KG is not liable for damage resulting from misuse.

Correct operation also includes following these instructions for use carefully and making sure machine inspection and maintenance is carried out on a regular basis.

When a Dentaureum product is finally no longer in use the disposal regulations of that particular country apply. Dentaureum or the dental trade is available to answer questions regarding the correct disposal of any specific product.

3.2. Hazard warning symbols

In the instructions for use, the following warning symbols were used:

-  **Warning** Suggests possible danger to life or health of persons.
Ignoring this warning may result in serious harm to health or even fatal injury.
-  **Caution** Suggests a possibly dangerous situation.
Ignoring this warning may result in slight personal injury or damage to equipment .
-  **Note** General information regarding the machine.

3.3. Warranty and liability

Our general terms for sale and delivery apply. Warranty and liability to persons or machinery is not applicable when attributable to one or more of the following points:

- Incorrect operation, use, assembly and maintenance of the machine
- Misuse of the machine
- Operation of the machine despite defect safety fixtures or incorrectly fitted or faulty safety and protective precautionary measures
- Failure to follow the advice in the instructions for use regarding transport, storage, assembly, operation and maintenance of the machine
- Failure to monitor working parts
- Personally conducted alterations to the build of the machine
- Unauthorized repairs.

3.4. Owner responsibility

The owner may only permit those persons to use the machine who

- Have been trained to use the machine and are familiar with the safety precautions
- Have read and understood the safety advice and instructions for use
- Have been instructed in the relevant accident prevention precautions.

3.5. Personnel responsibility

Before use, all persons wishing to operate the machine are obliged to

- Abide by the standard instructions regarding working safety
- Read and understand the safety precautions and instructions for use and sign in confirmation.

3.6. General advice on operating safety

- Do not make any alterations to the machine.
- Only use the machine if it is in perfect working order.
- Keep your workplace clean. An untidy workplace can increase the possibility of accidents.
- Do not place your hand into the machine whilst it is in motion. Wait until the casting arm has stopped moving before opening the lid. The casting chamber cannot be opened during the casting process.
- For your own safety use only materials and accessories which are recommended in the instructions for use. The use of other materials can increase the possibility of injury for the operator and is regarded as misuse.
- Always make sure the machine is switched off and the mains plug has been pulled out before maintenance.

3.7. Significant dangers



Warning The machine functions using high frequency electromagnetic waves! The machine must not be operated by persons wearing a pacemaker.



Warning There is a danger of burning if the melting crucible and the casting ring is touched. Always remove the hot casting ring after casting using appropriate tongs!



Warning Danger of Fire! Never leave any flammable objects in the melting and casting chamber.



Warning Always look through protective glass to observe the molten material.



Warning Only the metals named in section 3.1 may be melted. Light metals such as aluminium, magnesium and titanium in particular can lead to dangerous situations during melting and casting.

3.8. Disposal

i Note

This symbol indicates that products marked with it should not be disposed of together with household garbage. The legislator disallows commercial customers to return electronic waste via municipal collection points. Further information is available through Dentaurum or the dental trade.



3.9. Delivery

1	High frequency casting machine <i>megapuls compact</i> - 230 V	REF 090-620-00
1	Instructions for use with declaration of conformity	
1.5 m	Fabric reinforced fresh water hose with connection piece $\frac{3}{4}$ "', inner diameter 8 mm	
1.5 m	Water outlet hose inner diameter 8 mm	
2	Crucibles	
1	Mains cable	

4. Description of the induction casting machine ***megapuls compact***

4.1. Function

The ***megapuls compact*** is an easy to operate induction casting machine in a compact and space saving construction, which can be used to melt all dental alloys (exception: titanium and titanium alloys) and subsequently cast into a casting ring. It is equipped with manual operation and gradual heating adjustment and can be used universally. The machine functions using an energy transmission principle, a transformer, creating the so-called induction heating method. When the high frequency magnetic field is switched on, a secondary electrical current flows through the metal by means of induction. This converts into heat and causes the metal to melt.

The eddy current created within the molten metal causes the molten mass to become thoroughly mixed. The subsequent centrifugal force which casts the molten material into the form also helps with homogenisation.

The ***megapuls compact***'s outstanding characteristics are:

- High melting power with low energy consumption
- Homogeneous melting and casting method
- Low material wastage
- Extra work is reduced
- Easy to operate
- Space saving construction
- Friendly service.

4.2. Unit construction

The high frequency generator, which is surrounded by steel sheet housing, is the heart of the machine and complies with electromagnetic compatibility requirements. The HF generator produces an electromagnetic field and heats and mixes the molten metal to create a homogeneous molten mass. The induction coil (Fig. 4, Pos. 18) is cooled by water which prevents it from overheating.

- The melting crucible and casting ring can both be placed into the casting arm (Fig. 4) within the melting and casting chamber. The casting arm is equipped with weights to maintain a well-balanced and smooth run.
- The heating element, the induction coil (Fig. 4, Pos. 18), is situated in the base of the chamber and can be raised into position by pressing the „START“ button (Fig. 3, Pos. 12) after having adjusted the casting arm.
- The melting process is started by closing the lid and can be observed through the protective glass integrated within the lid (Fig. 2, Pos. 4).
- The melting process is completed by pressing the „CASTING“ button (Fig. 3, Pos. 14).

5. Installation



5.1. Positioning the machine

The chosen area must have a solid base. The machine must be positioned onto a stable and level table. The location must be clean and if possible free from dust.

-  **Caution** **Leave at least 20 cm distance between the casting machine and other objects. This will ensure sufficient air circulation.**
- Furnaces or other machines which generate heat should not be located directly next to the casting machine.**

5.2. Preparations in advance for water installation

The water supply pipe which runs from the stopcock (Fig. 5) to the spout at the back of the machine must be made from a fabric reinforced, fresh water pressure hose with a $\frac{3}{4}$ " connection thread at each end. The water outlet pipe, which runs from the hose nipple (Fig. 5) at the back of the machine to the siphon or allows the water to run directly into the domestic sewer, must be a hose with a diameter of 8 mm. The water should be able to drain away without resistance

-  **Caution** **Before connecting, please check the water pressure in the water supply network. It should be a minimum of 3 bar up to a maximum of 8 bar even during summer. If the water pressure is too low, a cool water circulation unit must be set up. If the water pressure exceeds 8 bar, a pressure reducing valve must be added to the water supply pipe.**
-  **Caution** **If the water supply network is known to carry sediment or pollution then it is necessary to fit a filter in order to avoid a water guard dysfunction.**

5.3. Preparations in advance for electro installation

The machine must be connected to a 230 V mains supply, the plug socket must contain a 16 A K fuse or a 16 A slow-blow fuse.

-  **Caution** **Any maintenance work at the plug socket or mains supply may only be carried out by an electrician.**

6. Operation and use

6.1. Inserting the casting ring and adjusting and balancing the casting arm

Once the machine has been successfully installed, operation can be started. Before each casting, the casting arm which holds the melting crucible and casting ring must be brought into a balanced position.

-  **Note** It is advisable to adjust the balancing weights before the wax has completely burned out in order to prevent the casting ring from cooling too much.

- First, open the tap to the cold water supply.
- Switch the machine on at the mains switch (Fig. 2, Pos. 7)
- Once the water is circulating properly, the „READY / ERROR“ display (Fig. 3, Pos. 8) will light up green.
- Place the melting crucible with the metal to be cast into the crucible insert (Fig. 4, Pos. 20) within the casting arm. Always preheat the melting crucible in the furnace without metal first!
- Place the preheated casting ring into the casting ring insert (Fig. 4, Pos. 21) and secure using the tightening lever (Fig. 4, Pos. 19).

- The casting ring arm should then be balanced out with the weights. Loosen the star-shaped nut (Fig. 4, Pos. 17) and by turning the balancing weights (Fig. 4, Pos. 16) on the spindle, balance out the casting arm. Re-tighten the star-shaped nut and remove the casting ring. This adjustment is usually carried out before the actual melting process has begun.

 **Caution** **The star-shaped nut must be securely tightened! Otherwise the casting arm or machine itself may become damaged during the casting procedure.**

6.2 Starting the melting process

Once the casting arm has been correctly balanced and the wax pattern in the casting ring has been entirely burned out, the actual melting procedure may begin.

i Note The hot casting ring can either be placed into the casting chamber directly before the melting procedure is started or after the metal in the crucible has been melted (pre-heating function). This prevents the casting ring from cooling down too much. It is advisable to pre-heat the alloy if larger amounts of metal are to be melted.

i Note When melting gold-colored precious alloys, use a ceramic crucible with a graphite insert. When melting silver-colored precious alloys, use only the ceramic crucible. This also applies to palladium base alloys. Vitrify the crucible with melting powder prior to use.

i Note The potentiometer „HEATING“ (Fig. 3, Pos. 13), for the heat rate and the duration of the pre-heating function must be adjusted individually for each type and amount of metal alloy so that the melting does not occur entirely to 100 % during pre-heating.

- Turn the potentiometer „HEATING“ (Fig. 3, Pos. 13) to choose the melting degree required. Select the power so that, depending on which metal alloy is to be melted, the process takes less than one minute but more than 30 seconds. If there is a large amount of metal to be melted, then the process may take longer than 60 seconds. If a graphite crucible is in use within the ceramic crucible, reduce the heating power considerably so that the graphite crucible may heat up slowly and therefore melt the precious metal gently.
- Select the spinning duration with the alloy selection switch „GOLD/OTHER ALLOYS“ (Fig. 3, Pos. 10). When „GOLD“ is selected, the spinning time increases. When „OTHER ALLOYS“ is selected, the machine runs at maximum acceleration strength and the spinning time is reduced.
- Position the casting arm over the induction coil until an acoustic signal can be heard.
- Press the „START“ button (Fig 3, Pos. 12) to raise the induction coil.
- Close the casting chamber lid, the melting process begins and the melting display „HEATING“ (Fig. 3, Pos. 9) lights up.
- Observe the melting metal by looking through the protective glass. When the metal is almost completely molten, the casting ring can be inserted.
- Place the hot casting ring into the insert (Fig. 4, Pos. 21) using suitable tongs and clamp securely.
- Once the lid is closed, the melting process continues immediately. It is possible to turn the potentiometer for heating (Fig. 3, Pos. 13) up or down during the melting process to correct the efficiency.

i Note The melting process can be stopped by pressing the red „STOP“ button (Fig. 2, Pos. 6) (see also chapter 6.6).

 **Caution** **Fire Hazard! Very high temperatures can be reached during the melting process in the casting chamber.**

6.3. Starting the casting process

When the metal is completely molten, press the casting switch „CASTING“ (Fig. 3, Pos. 14). The electric motor accelerates the casting arm. The centrifugal force causes the molten metal to flow into the hot casting ring.

6.4. Opening the casting machine lid and removing the casting ring

Once the casting arm has completely stopped rotating, the lid may be opened and the casting ring removed.



Caution Risk of burns during removal of hot casting ring! The casting ring and crucible must only be removed using suitable tongs and additional protective gloves.



Caution Do not forcefully open the lid! The casting chamber lid is locked during the casting process and as long as the casting arm is still in motion.

6.5. Switching the machine off

To switch the machine off, close the casting chamber lid and turn off at the mains switch (Fig. 2, Pos. 7).



Note Do not switch the machine off to cool down between casting procedures. It may only be switched off at the mains switch after the last casting has taken place.



Note The machine itself automatically turns the water supply off. There is no need to turn the tap off manually after every casting, however if the machine stands for a longer period of time e. g. over the weekend, then the main tap must be closed.

6.6. Using the „STOP“ button

During correct operation it is not necessary to use the „STOP“ button (Fig. 2, Pos. 6). It is only used when the working procedure is faulty due to a malfunction or disorder.

The „STOP“ button (Fig. 2, Pos. 6) causes the current working procedure e.g. melting the metal, to be cancelled immediately and the induction coil to descend.

7. Cleaning and maintenance



Warning Always switch the machine off and remove the plug from the mains supply during any servicing or maintenance work. When service or maintenance work is carried out, always ensure a second person with electrical knowledge is nearby. Many repairs may only be carried out by authorized personnel or by the Dentaurum Service Team.

7.1. Cleaning the water supply inlet

Every 6 months the water filter in the fresh water inlet (Fig. 5) must be cleaned:

- Whilst the machine is still on, close the water stopcock in the laboratory. This way the circulating water within the machine is no longer under pressure.
- Then switch the machine off and remove the plug from the mains supply.
- After the water supply has been closed and the machine has been switched off, unscrew the fresh water pressure hose from the machine (Fig. 5).
- Close to the machine, within the fresh water connection is a fine filter which can be removed using tweezers (Fig. 5). Clean the fine filter under running tap water with the aid of a brush or in an ultrasonic unit.
- Replace the cleaned fine filter back into the opening in the fresh water connection and screw the fresh water pressure hose back on. Make sure the seal between the fresh water connection and the connecting piece of the hose is in place.
- Always check if the connection is tight before switching the machine back on and opening the water stopcock again.

7.2. Cleaning the machine

Wipe over the machine every now and then with a damp cloth. Do not use any strong detergents or tools for cleaning. Remove any casting residues or deposits from the casting arm immediately after casting and check for good mobility. Regularly remove deposits from the casting chamber. Always ensure meticulously that no metal pieces land in the coil rails.

7.3. Handling the melting crucible

In order to achieve excellent casting results, please observe the following points:

- Store the crucible (REF 090-611-00) in a dry and dust-free environment where it cannot be knocked.
- Check the crucible after every casting for possible damage or wear. Crucibles which are cracked or damaged may no longer be used.
- Carefully remove residues from the crucible. Remove large pieces of residue using tweezers and then blow clean with compressed air.
- Mark each crucible on the outside using a graphite pencil in order to indicate which alloy has been melted inside.

i Note Use one crucible for each different alloy.

- It is the crucible material characteristics which forces the ceramic industry to work with large discrepancies. For this reason it may occur that the crucible gets stuck in the clamp. It is possible to make it fit by filing the crucible.

Due to the delivery conditions of the ceramic industry it is not possible to determine an average lifespan or guarantee against damages to the ceramic crucibles during transport.

The following crucibles are suitable for the induction casting machine ***megapuls compact***:

Ceramic crucible	10 pieces	REF 090-611-00
Graphite insert	10 pieces	REF 090-615-00

8. Correcting faults

The casting machine is equipped with an error warning system. The following errors can be the cause of a fault:

Error	Reason	Correction
"READY/ERROR" display (Fig. 3, Pos. 11) lights up red	<p>The water circulation has been stopped, flow guard is possibly defect, water pressure too low</p> <p>Machine is overheated due to poor air circulation</p> <p>Machine is overheated due to too many castings</p>	<p>Check water circulation Replace flow guard Check water pressure</p> <p>Leave a space of 20 cm between the casting machine and the next piece of equipment or wall</p> <p>Integrated thermo protection device interrupts the melting function for 5 min A maximum of 15 castings may be undertaken in succession With the water circulation unit switched on max. 7 castings then 10 min rest!</p>
No LED lights up after switching on.	<p>Automatic circuit breaker at the back of the machine is switched off</p> <p>Mains supply is off</p> <p>Mains switch is defect</p>	<p>Switch the automatic circuit breaker on</p> <p>Check mains supply Replace mains switch</p>
No LED lights up after switching on.	<p>Mains adapter fuse defect</p> <p>Mains adapter defect</p>	<p>Check the fuses and replace them if necessary</p> <p>Mains adapter must be replaced (call customer service)</p>
The induction coil cannot be raised	<p>The casting arm has not been correctly positioned</p> <p>The position of the casting arm has not been recognised by the integrated light barrier</p> <p>The fuse or motor for the lift mechanism is defect</p> <p>"START" button is defect</p> <p>Switch for the lower end position is defect</p>	<p>Bring the casting arm into position (Confirmation with acoustic "peep" signal)</p> <p>Light barrier defect (call customer service)</p> <p>Check the fuse and change if necessary, the motor for the lift mechanism is defect (call customer service)</p> <p>"START" button must be replaced (call customer service)</p> <p>Switch for the lower end position must be replaced (call customer service)</p>
The melting procedure has taken place but when the "CASTING" button is pressed, nothing happens	<p>The control system is defect</p> <p>The induction coil has not been completely lowered</p> <p>The induction coil is mechanically blocked</p> <p>Casting motor is defect</p> <p>Switch for the upper end position is defect</p>	<p>Electric control must be replaced (call customer service)</p> <p>Check the fuses and change if necessary, the motor for the lift mechanism is defect (call customer service)</p> <p>Clean the induction coil rails</p> <p>Motor must be replaced (call customer service)</p> <p>Switch for the upper end position must be replaced (call customer service)</p>

If you are not able to correct the fault using this table, please call your relevant service technician or call Dentaaurum Technical Service – Machines directly.

Phone: +49 72 31/803-211 | info@dentaaurum.com

9. Spare parts

Ceramic crucible	10 pieces	REF 090-611-00
Graphite insert	10 pieces	REF 090-615-00
Protective glass	1 piece	REF 908-271-00

10. Functional diagram

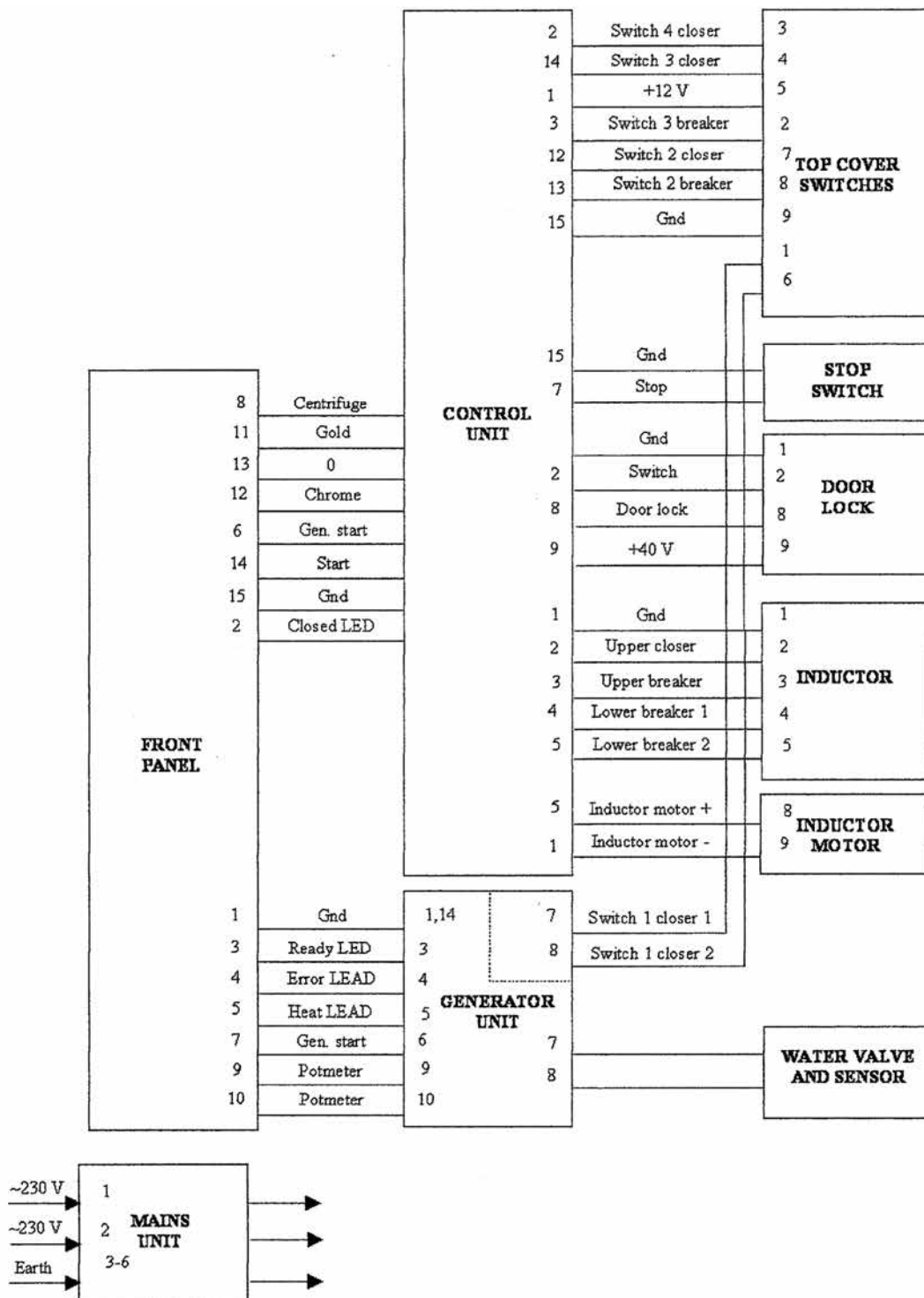

11. Technical data

Mains voltage	230 V
Mains frequency	50/60 HZ
Max. power consumption	2.4 kW
Average power consumption	1.5 kW
Starting torque	0...21 Nm
Min. melting quantity	15 g precious alloy, 15 g CoCr, NiCr, Pd
Max. melting quantity	100 g precious metal, 70 g CoCr, NiCr, Pd
Max. power output	2.2 kW
Cooling water flow	min. 2 l/min
Ambient air temperature for operation	15...40 °C/59...104 °F
Storage temperature	5...40 °C/41...104 °F
Max. relative ambient humidity	70 %
Measurements [width x height x depth]	560 x 425 x 630 mm
Weight	55 kg

Dentaurum

Germany | Benelux | España | France | Italia | Switzerland | Australia | Canada | USA
and in more than 130 countries worldwide.



DENTAURUM
QUALITY
WORLDWIDE
UNIQUE

➔ For more information on our products and services, please visit www.dentaurum.com

Date of information: 2023-10

Subject to modifications

D
DENTAURUM